

Nine9®

Main Catalog

2019



Product Milestone





Productivity, Creativity & Infinity

US 7,108,460 B2

US 7,287,937 B2

US 7,431,541 B2

US 7,455,487 B2

US 8,192,114 B2

US 9,579,812 B2

US 9,718,137 B2

US 9,764,396 B2

US 9,789,550 B2

US 9,937,566 B2

US 10,092,964 B2

-
-
-
-
-
-
-
-
-

Nine9 company began in 1994 and with the development of special tools, boring heads and accessories.

The Nine9 logo was commissioned in 1999.

It comes from the Chinese characters meaning "long life and durability" – words which aptly describe all Nine9 tools. 99 is the largest 2 digit number, indicating maximum product endurance.

Nine9 tools whilst being "special" in the industry, are standard in our product range. NC spot drills , super power drills , boring tools , engraving tools , i-Center , NC helix drills , chamfer mill. Those established Nine9 as a market leader and innovator in the cutting tool field.





NC Spot Drill

60° ~ 145°

One tool will perform multiple applications

- ➔ NC Spot Drill with indexable carbide insert.
- ➔ High efficiency! Long tool life! Cost saving!
- ➔ Ideal for CNC lathes, CNC turning centers & machining centers.
- ➔ Increase cutting speed with coated carbide inserts.

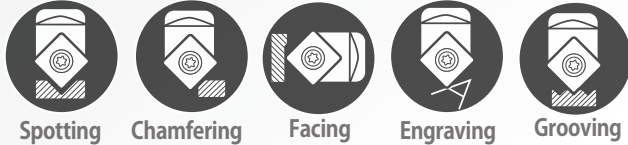

Corner Rounding

RC0.5 ~ 6.0mm

Various corner radius inserts can fit on same holder

- ➔ Inserts are CNC ground for precision radius and location. Stand long tool life.
- ➔ Produces smooth and excellent surface finish on workpiece.
- ➔ Combination of corner rounding and 45° chamfering applications on same insert.
- ➔ Higher cutting speed and feed rate.



All inserts fit in the same tool holder!



Indexable Center Drill « i-Center »

Long Tool Life! **Pilot dia. 1 ~ 10mm**
No need tool length resetting

- ➔ Excellent repeatability by insert type within 0.02mm in radial direction.
- ➔ Shorten set up and center drilling time.
- ➔ 0.05mm axial positional accuracy.
- ➔ Coolant can be supplied through the center of the holder.

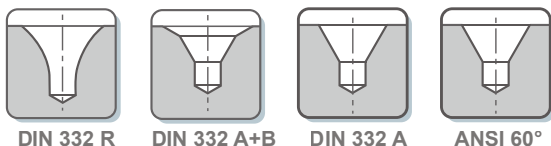

30° / 45° / 60° / 90°

Engraving



**Different Angle!
Burr-Free!**



- ➔ Multi-side grinding, excellent performance.
- ➔ Higher cutting speed and DOC.
- ➔ No need to reset tool length.
- ➔ No resharpener required.
- ➔ Widely used for marking on machine components, medical components, gun components, mold and die, automotive parts, gears, bearings, and luxury goods.



60° / 90°

NC Deburring



**Insert has 6 flutes,
6 times higher feed rate.**



- ➔ Ideal for fine hole deburring.
- ➔ Smallest chamfer diameter $\varnothing 0.5\text{mm}$.
- ➔ Achieve high speed and feed rate on CNC machine.
- ➔ Retain exceptional positional accuracy of the deburring depth and diameter.



45°

Chamfer Mill



**Front and Back Chamfering.
Ultra high speed & feed rate**



- ➔ Smallest chamfer insert in the world.
- ➔ Smallest counter sink diameter $\varnothing 7\text{mm}$.
- ➔ 4 times faster and up to 10 times higher feed rate than competitors.
- ➔ Dual relief angle insert, special edge honing and optimized coated.

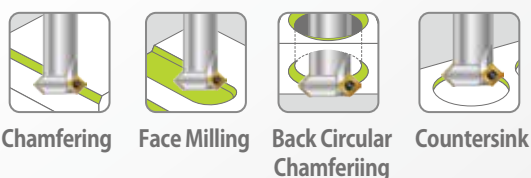



NC Helix Drill

ø13 ~ ø65mm

Ideal for automation production
Excellent swarf removal

- ➔ Cuts materials by Helical interpolation.
- ➔ Just six tools can drill ø13~ø65mm holes.
- ➔ Serred cutting edge minimizes cutting chips.
- ➔ Good for drilling on soft and long cutting chip material.
- ➔ Circular ramping milling, maximum ramping angle is 20°.
- ➔ New remarkable tool design to eliminate machining process.
- ➔ Example:

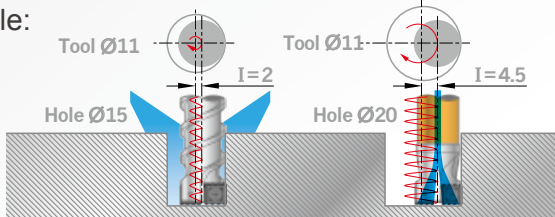

Super Power Drill

5xD ~ 10xD

A truly straight hole
can be expected.

5-10xD : ø19 ~ ø40mm 12xD is also possible

- ➔ The unique design of insert pocket provides the best accuracy and rigidity of center insert.
- ➔ The center and peripheral inserts are positioned in order to divide the cutting chips into smaller spiral shape.
- ➔ Better surface finish. It can reduce your roughing operation.
- ➔ Lateral cutting forces can be absorbed by center insert due to a patented pocket design.



Super Drill

3xD & 4xD

Smallest indexable drill
from 10mm.

3xD : ø10 ~ ø30mm 4xD : ø16 ~ ø30mm

- ➔ Smallest indexable drill from 10mm.
- ➔ Same insert for outer and inner insert.
- ➔ Chip breaker of SD insert provides excellent chip control property due to its engineered design.
- ➔ Better surface finish and better diameter accuracy.
- ➔ Possible to drill into angled surfaces without pre-drilling.





ø10 ~ ø315mm

Power Mill

**Indexable milling cutter 10mm.
Higher wear resistance!**



- Patented Dual Relief Angle Insert.
- Precision ground insert performs efficient repeatability and excellent accuracy.
- Special geometry design helps the strength of cutting edge in shoulder milling operation.
- High precision providing good productivity and surface finish.
- Two types of shank - Screw fit type and cylindrical type.



ø5mm ~ ø50mm

Boring Tool

**Easy Adjustment! No backlash!
G6.3 /10,000 r.p.m.**



- Eccentric mechanism boring bars.
- Adjusting range :±0.1mm
- ø5mm~ø50mm boring bars are interchangeable.
- Ideal for small hole boring with excellent accuracy.
- Good for fine boring operation on milling machines, machining centers and special purpose machines.
- Replace solid carbide reamers.



Accessory



- **DC Slim Chuck**
Extension adapter
DC-E Collet
- **Extension Bar**
Steel & Solid Carbide Type
- **Torque Screwdriver**
0.6~5.5 Nm Torque Screwdriver

Modular System

Extension bar's quick change head allows for fast and easy switching between different drilling or milling heads.

For NC Spot Drill, NC Helix Drill, Power Mill and Direct Adjusting Boring Bar

- Steel Type & Solid Carbide Type
- With internal coolant hole

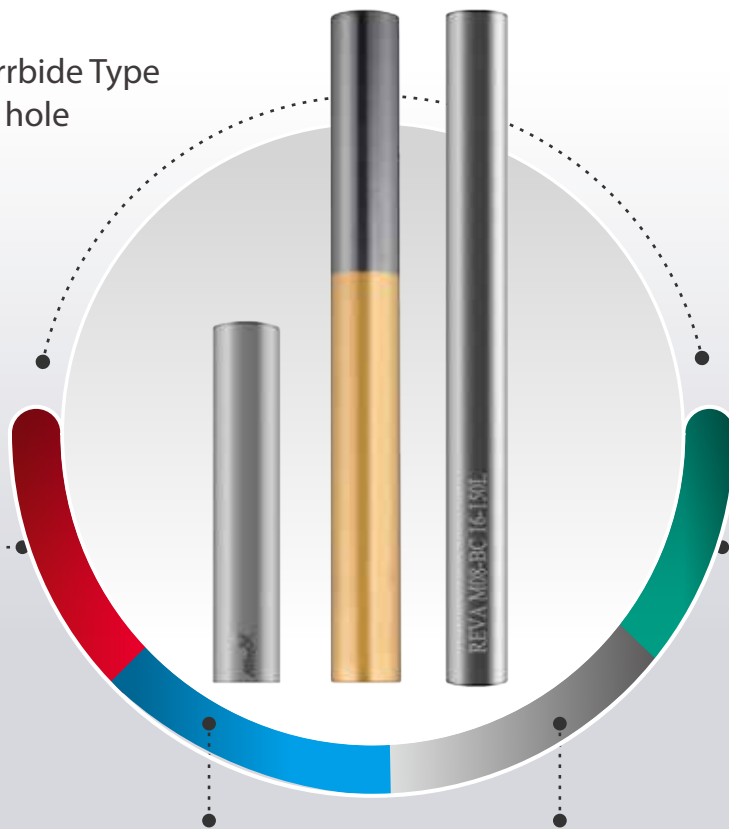

NC Spot Drill

NC Helix Drill

Power Mill

Boring Head



Spotting
Engraving
Grooving
Chamfering

see P1-7

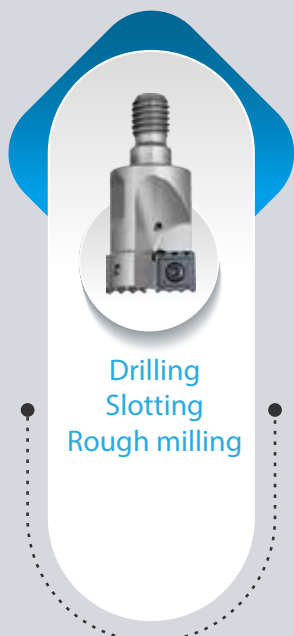

Drilling
Slotting
Rough milling

see P2-6

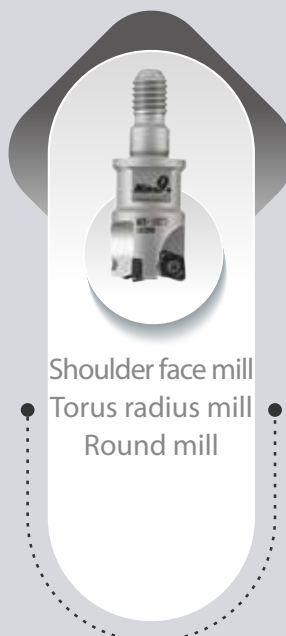

Shoulder face mill
Torus radius mill
Round mill

see P4-4

























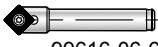





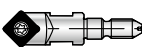

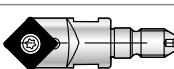
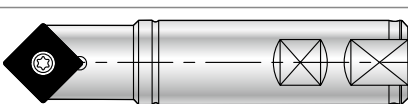
Direct adjusting
Fine boring

see P5-18

Table of Contents

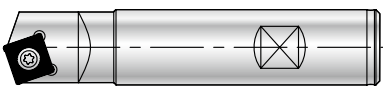
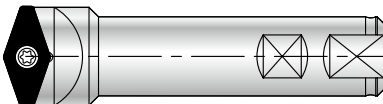

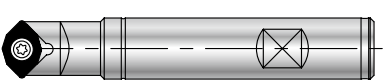







1 SERIES	NC Spot Drill	1-1
	Corner Rounding	1-17
	i-Center	1-29
	Engraving	1-39
	NC Deburring	1-53
	Chamfer Mill	1-55
	2 SERIES	NC Helix Drill
3 SERIES	Super Power Drill / Super Drill	3-1
4 SERIES	Power Mill	4-1
5 SERIES	Boring Tool	5-1
6 SERIES	Accessory DC Slim Chuck Extension Bar Torque Screwdriver	6-1

NC Spot Drill

Angle	Holder	Insert	D min.	D max.					Page
60°	 99616-09V	 V9MT0802	1	9	•	•	•	•	1-4
	 99616-13V	 V9MT12T3	2	13	•	•	•	•	
82°	 99619-V082-3/8	 V0820802	2	9	•	•	•	•	1-5
	 99619-V082-5/8	 V08212T3	2	14	•	•	•	•	
90°	 99616-06-6	 N9MT05T1	1	6	•	•		•	1-6
	 99616-08-8	 N9MT0602	1	8	•	•	•	•	
	 99616-10...	 N9MT0802	2	10	•	•	•	•	1-7
	 99616-10-M5								
	 99616-14...	 N9MT11T3	3	14	•	•	•	•	1-9
	 99616-14-M8								
	 99616-22	 N9MT1704	3	22	•	•	•	•	1-11
 99616-25-CT28	 N9MT2204	4	25	•	•			1-12	
100°	 99616-20-100		3	16	•	•			
120°	 99616-20-120	 N9MT11T3	3	17	•	•			1-13
142°	 99616-20-142...		3	18	•	•			1-14
	 99619-V142...	 V1421604	2	32	•				
145° + 90°	 99616-10 / 14 / 22 ...	 WSP / M4-M16	3.3	20	•	•	•		1-15

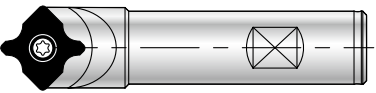



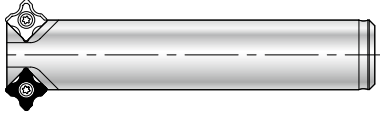

1

Corner Rounding

Angle	Holder	Inserts	D min.	D max.				Page
RC	 99616-06...RC	 N9MT05T1RC (2 cutting edge insert)	0.5	1.0	•	•		1-18
	 99616-14...RC	 N9MT11T3RC (2 cutting edge insert)	1.0	3.0	•	•		1-19
	 99616-22...RC	 N9MT1704RC (2 cutting edge insert)	4.0	6.0	•	•		1-20
R	 99616-16-25R	 N9MT11T3R (4 cutting edge insert)	1.0	3.0	•	•		1-22
	 99616-16-30R		1.0	3.0	•	•	•	
	 99616-25-40R		1.0	3.0	•	•	•	









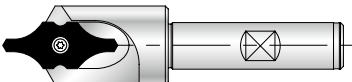

1

Large 45° Chamfering

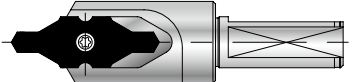

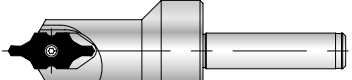









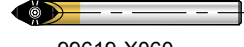

Angle	Holder	Inserts	D min.	D max.				Page
45°	 99616-18...LA	 N9MT11T308LA (4 cutting edge insert)	6	18	•			1-24
	 99616-28...LA		16	28	•	•	•	

1



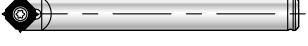

Center Drilling / i-Center

Angle	Holder	Inserts	D min.	D max.				Page
R		 DIN332 Form R	1.0	10	•			1-33
A+B		 DIN332 Form A+B	1.0	10		•		
A		 DIN332 Form A	2.0	3.15			•	
60°	 99616-IC...	 ANSI 60°	5/64"	3/8"			•	







1 Engraving Tools





Angle	Holder	Inserts	W min.	W max.	T max.			Page
30° 45° 60°	 99619-X060...	 Radius Angled	0.2	1.36	1.0	•	•	1-42
		 Radius Form	R:0.2	1.39	1.0	•	•	1-43
45°	 99619-V045...	 V04506T1W	0.45	2.1	2.0	•	•	1-44
60°	 99619-V060...	 V06006T1W	0.25	2.7	2.0	•	•	1-45
60°	 99619-W060...	 W06004S	0.1	1.1	0.6	•	•	1-46
60°	 99616-10...SW	 N9MT0802	0.2	1.1	0.8	•	•	1-47
90°	 99616-10...SW	 N9MT0802	0.2	2.0	0.9	•	•	



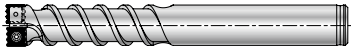

1 NC Deburring

Angle	Holder	Inserts	W min.	W max.			Page
60°	 99619-X060...	 X060A60T6	0.3	2.0	•	•	1-54
90°	 99619-X060...	 X060A90T6	0.5	3.5	•	•	

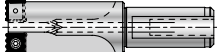
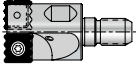



1 Front and Back Chamfer Mill

Angle	Holder	Inserts	W min.	W max.			Page
45°	 99616-C02, C04, C06	 N9GX04T002 (4 Cutting edge)	6.8	13.2	•	•	1-57
	 99616-C10 ~ C52	 N9GX... (4 Cutting edge)	7	32	•	•	1-58



2 NC Helix Drill						
Diameter	Holder	Inserts	Max. Drilling Depth			Page
Ø13~Ø50	 99321	 N9MX...	75	•	•	2-5
Ø42~Ø65	 99321-025-4265		50	•	•	
Ø13~Ø50	 99323		160	•	•	2-6

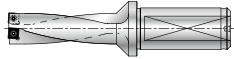





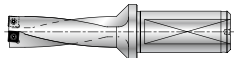





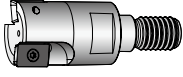

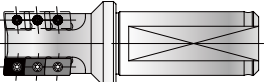
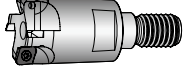
3 Super Power Drill 5xD~10xD						
Diameter	Holder	Inserts	Drilling Depth			Page
Ø19~Ø23	 99307	 99307-CD6	100~200	•		3-5
Ø24~Ø26			100~250	•		
Ø27~Ø28		150~250	•			
Ø29~Ø33		 99307-CD8	150~300	•		3-6
Ø34			150~350	•		
Ø35~Ø40			200~350	•		

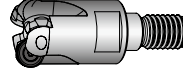
Super Drill 3xD

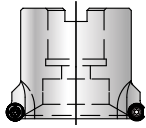
Diameter	Holder	Inserts	Drilling Depth				Page
Ø10~Ø30	 99313	 N9GX...	30~90	•	•	•	3-12

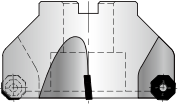

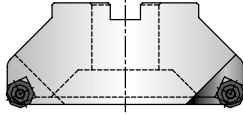
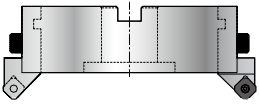







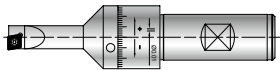

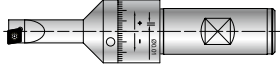
Super Drill 4xD

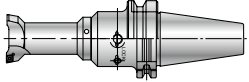
Ø16~Ø30	 99314	 N9GX...	64~120	•	•	•	3-13
---------	--	--	--------	---	---	---	------

Diameter	Holder	Inserts			Page
Ø10 ~ Ø25	 99802-M..A.. / 99805-M..A..	 A9MT/GT/FT	•	•	4-4
	 99802-BC..A..				
Ø20 & Ø25	 99522		•	•	4-3
Ø10 ~ Ø26	 99802-M..C.. / 99805-M..C..	 C9MT	•	•	4-7
	 99802-BC..C..				
Ø16 ~ Ø35	 99802-M..R..	 R9MT	•	•	4-10
	 99802-BC..R..				
Ø50 ~ Ø100	 99802-MC			•	4-9
Ø32	 99542-032			•	
Ø50 ~ Ø125	 99542	 N9GJ11T3F2-O		•	4-13
Ø63, Ø80 & Ø100	 99543			•	
Ø80 ~ Ø315	 99511	 N9MT11T3HR300		•	4-15

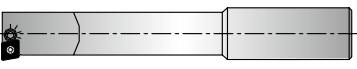
5

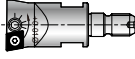
Boring Tool

Diameter	Holder	ISO Insert	Boring Depth	Adjusting Range		Page
Ø6.5 ~ Ø25.5	 99101	 G grade	21 ~ 50	±0.5	•	5-5
Ø4.9 ~ Ø25.1	 99121	 G grade	15 ~ 50	±0.1	•	5-6
Ø5 ~ Ø50	 99146	 G grade	10 ~ 70	±0.12	•	5-8
Ø5 ~ Ø20	 99151	 G, F grade	20 ~ 100	±0.1	•	5-12
Ø16 ~ Ø50	 99021	 G, F, M grade	66 ~ 140	±0.1	•	5-17
Ø14 ~ Ø25	 99043	 G grade	-	±0.1	•	5-18



Inserts >> Quick Pick

Nine9 inserts apply for modern machining by its special geometry which is able to run at higher speed and feed. In addition, the indexable insert eliminates the tool's changing time. Carbide insert with latest coating technology extends tool life dramatically. Nine9-insert helps you to save money and increase productivity.

Products	Grade	Coating	P Steel	M Stainless Steel	K Cast Iron	N Non-Ferrous	H Hardened Steel Up to 56 HRC	S Titanium
NC Spot Drill	NC10	TiAIN		●	●	◎		
	NC40	TiN	●	○	◎			
	NC2071	TiN	●	◎	●	◎		
	NC9076	DLC		◎		●		◎
	NC60	Cermet	◎				●	
Corner Rounding	NC2071	TiN	●	○	●			
	NC9036	DLC		●		●		◎
i-Center	NC2033	TiAIN	●	○	●		○	
	NC5074	Helica	●	○	◎			
Engraving	NC2032	TiAIN	●	○	●			
	NC2071	TiN	◎	●		◎		
	NC9031	TiN		◎		●		
	NC2035	ALDURA	◎		○		●	
	NC9036	DLC		◎		●		◎
NC Deburring	NC2032	TiAIN	●	○	◎	●		
Chamfer Mill	NC2032	AlTiN	●	○	●		◎	
	NC9071	TiN	○	●		●		

● Best ◎ Suit ○ Possible



Features

Universal grade for non-ferrous metal, cast iron and stainless steel.
General purpose, fully ground cutting edge and relief angle.

Universal grade for all unhardened steel, and tool steel up to 1200N/mm².
General purpose, fully ground cutting edge and relief angle .

Universal grade for all unhardened steel, free cutting steel, tool steel up to 750N/mm² and cast iron.
The cutting geometry has been designed to optimize the tool's performance and to use in high speed machining.

For non-ferrous material such as aluminum, acrylic, brass, copper, titanium and long cutting chip materials.
High positive geometry and sharp edge produces excellent surface finish.

For hardened steel up to 56 HRC.
Cermet insert reduces heat and low tool wearing at the cutting edge.

Universal grade for all unhardened steel and cast iron.
The cutting geometry has been designed to optimize the tool's performance.

For non-ferrous material, aluminum, acrylic, brass, copper, stainless steel (low carbon contain) and titanium.
High positive geometry and sharp edge produces excellent surface finish.

For carbon steel, alloy steel, high alloy steel and cast iron.
2 Cutting flutes design same as carbide center drill for high performance speed and feed rate.

Helica coating provides a smooth cutting and helps the cutting chip to be removed easily.

For all kind of steel from 30~50 HRC, carbon steel, alloy steel and cast iron.
TiAlN coating provides a longer tool life.

Universal grade for all kind of steel<30 HRC, non-ferrous metal and stainless steel.
The cutting geometry of this insert has been designed with strong cutting edge.

For non ferrous metal, aluminum, brass, copper, plastic, acrylic and stainless steel.
Very sharp edge for shallow engraving.

For steel with heat treatment up to 56 HRC.
Latest ALDURA coating to reduce heat and tool wear.

For non-ferrous material and titanium.
Very sharp edge for shallow engraving.

For all kinds of steel from < 40 HRC, carbon steel, alloy steel, cast iron, aluminum and non-ferrous metal.

For carbon steel, alloy steel, cast iron and hardened steel up to 56 HRC.
Upgraded AlTiN coating provides a very long tool life.

For non-ferrous metal, aluminum, al-alloy, brass, copper and stainless steel.
Very sharp produces excellent surface finish.



Inserts >> Quick Pick

Products	Grade	Coating	P Steel	M Stainless Steel	K Cast Iron	N Non- Ferrous	H Hardened Steel Up to 56 HRC	S Titanium
NC Helix Drill	NC5072	TiAlN	●	●	◎	◎	○	◎
	NC2032	TiAlN	◎	○	●	◎	◎	○
Super Power Drill / Super Drill	NC2032	AlTiN	●	●				
	NC40	TiN	●	●	◎			◎
	NC2032	AlTiN	●	○	●		◎	●
	NC40	TiN	●	●				
Power Mill	NC2032	AlTiN	●	○	◎			
	NC5072	AlCrN	●	◎	●			
	NC2033	TiAlN	●	◎	●			
	NC40	TiN	●	●				●
	NC2032	AlTiN	●	○	●		◎	
	NC9031	TiN				●		
	NC30	AlTiN	●		◎		◎	
Boring Tool	NC30	TiAlN	●	◎	●			
	NC2032	AlTiN			●			
	NC2033	TiAlN	●	◎	●			
	NC9036	DLC				●		
	U-NC9036	DLC				●		

● Best ◎ Suit ○ Possible

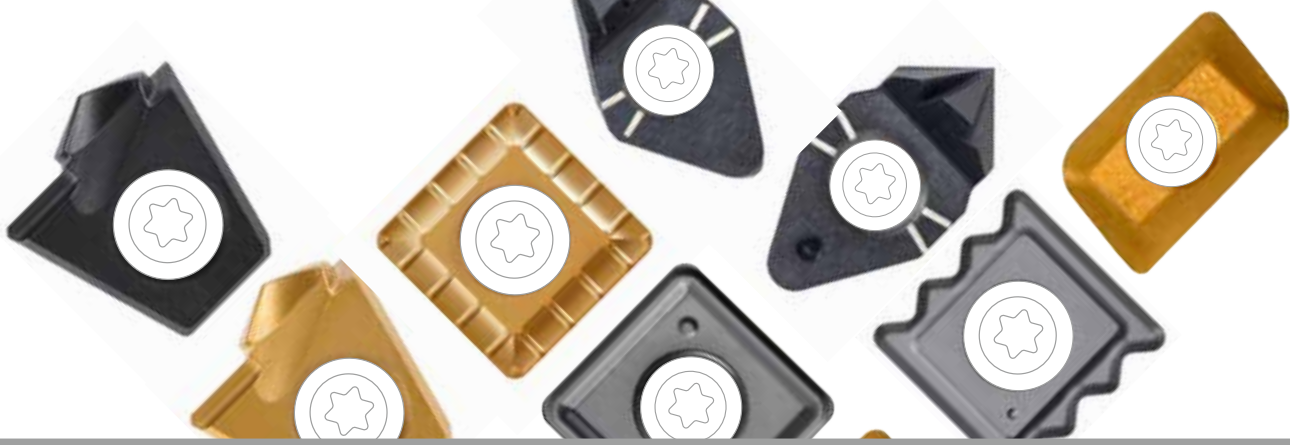

Features

General purpose, suitable for almost all kind of steel, stainless steel and Titanium.
Recommended while clamping devices is weak or apply on low power machines or deep hole drilling.

Design for high performance cutting, special good for cast iron and hardened material <HRC50°.

Fully ground, honed cutting edge.
For carbon steel & alloy steel C<0.3% and stainless steel.

Fully ground, honed cutting edge.
For carbon steel & alloy steel C>0.3% and stainless steel.

For carbon steel, alloy steel, casting iron, stainless steel and hardened steel up to HRC 50.

Tougher insert with special chip breaker, TiN coated, for low carbon steel and stainless steel.

Special chip breaker design. Good for hard cutting carbon steel and alloy steel.

Special chip breaker design. Good for all kinds of steel.

For better surface roughness. Good for all kinds of steel.

Sharp cutting edge and high positive angle. Good for stainless steel.

Special chip breaker design, sharp cutting edge. Good for carbon steel, low alloy steel.

Good for Al, Al-alloy, Copper, Copper alloy and Non-Ferrous metal, etc.

Submicron carbide insert. Flat cutting edge design, universal type for all kind of materials.

Universal grade for casting iron, carbon steel, alloy steel, stainless steel.

For high speed cutting of casting iron.

Good for carbon steel, alloy steel, stainless steel.

Long tool life. Good for Al, Al-alloy, Copper and non ferrous metal.

It's a super finishing insert with large corner radius for high feed rate for cutting Al, Al-alloy and non-ferrous metal.



No Need To Choose Nine9 Does It All! >>



Cost Saving



Time Saving



Highly Efficient



Long Tool Life

► Various inserts can fit on the same tool holder

► Various Applications

► Spotting

► Corner Rounding

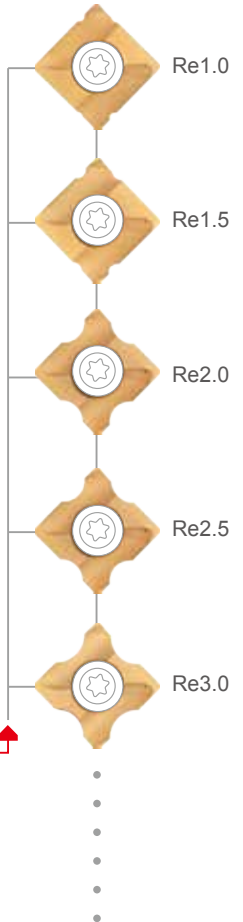
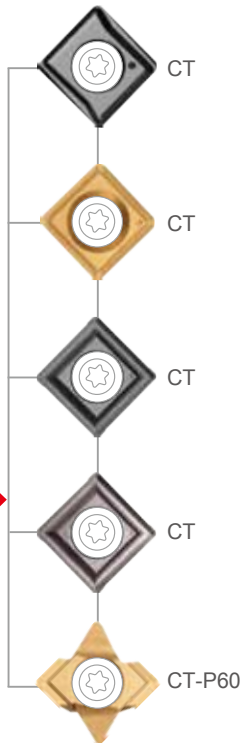

A New Drilling Concept!

0.5xD of spotting

Many drill manufacturers and suppliers state that their drills start drilling on the solid material. You can look forward to the following benefits when using the NC Spot Drill to drill a spot that is half of the drilling diameter.

► Drill Benefits >>

- **Higher feed rate.**
Why? Because the drill is guided at the strongest part of cutting edge.
- **Better center position.**
Why? Because the spotting is done by a single cutting edge which is out of center, and similar to boring operation.
- **Increased tool life.**

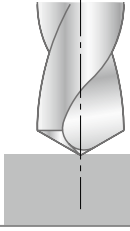
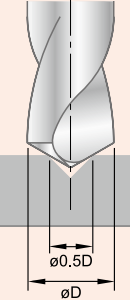
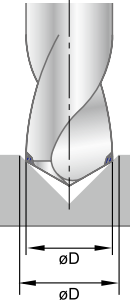
NC Spot Drill	Without Spotting	0.5xD Spotting	Larger Spotting
<ul style="list-style-type: none"> • Better center position! • Longer tool life! 	<ul style="list-style-type: none"> • Drill has less position accuracy and diameter tolerance. 	<ul style="list-style-type: none"> • Best result! • Higher speed and feed rate. • Better position accuracy and diameter tolerance. 	<ul style="list-style-type: none"> • Longer spotting time! • Guided at the weakest corner of drill. • Shorter tool life
	 Unstable tool life	 Ø0.5D ØD	 ØD ØD
	✗	○	✗

► Various Applications of NC Spot Drill >>

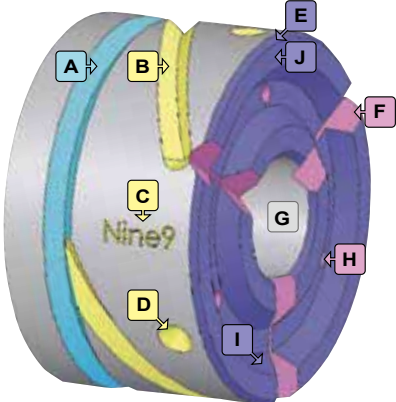
Turning Center	Fig	Applications	Multifunctional Cutting Tool
	A	Grooving	Use on CNC lathes CNC turning centers Machining centers Milling machines SPM machines
	B	Helical groove milling	
	C	Engraving	
	D	Spot drilling	
	E	Chamfer turning	
	F	Face groove milling	
	G	Internal turning	
	H	Spot drilling on end surface	
	I	Internal Chamfering	
	J	Face grooving	





NC Spot Drill >>

NC Spot Drill with indexable carbide insert.

High efficiency! Low cost!

CNC lathes, CNC turning centers and machining centers.

1

Features

NC Spot Drill

- ▶ Spotting produces better hole position and geometrically uniform holes
- ▶ Available shank diameter- Ø5, Ø6, Ø8, Ø10, Ø12, Ø16, Ø20, Ø25mm, Ø3/8", Ø1/2", Ø5/8", Ø1/4", Ø3/4", M5, M6 and M8.
- ▶ One tool will perform multiple applications
 - Long tool life.
 - Each insert has 2 or 4 cutting edges.
 - Suitable for spotting, chamfering, grooving and engraving.
 - 60° / 82° / 90° / 100° / 120° / 142° angle for different applications.
 - Increase cutting speed with coated carbide inserts.



- ▶ Machining Center
 - a** Engraving
 - b** Spotting
 - c** Chamfering
 - d** Grooving

▼ ALL IN ONE!!

Spotting

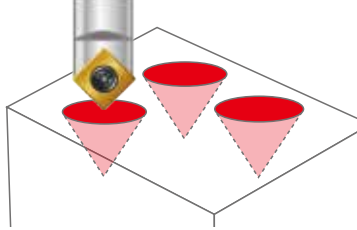

Chamfering

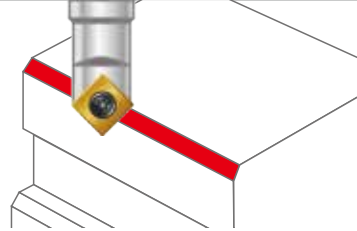

Grooving

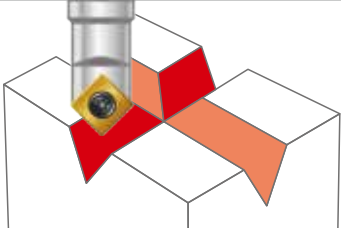

Engraving

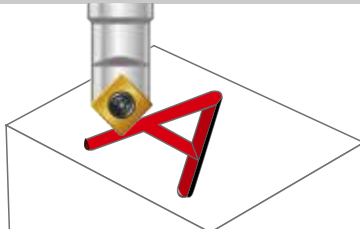

W Spotting

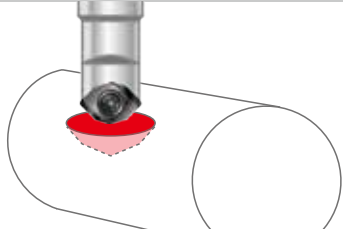

Corner Rounding

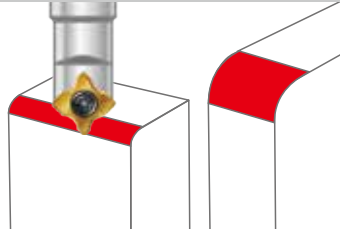

- ▲ CNC Lathes
- a** External and internal chamfering
 - b** Grooving
 - c** Centering
 - d** Facing



1

NC Spot Drill

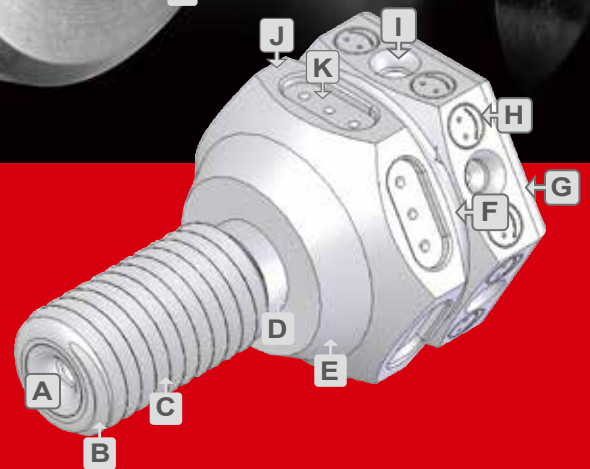

- Multifunctional:
- | | | | |
|--------------------------------------|--------------------------|--------------------------|--------------------------|
| A Center Drilling | I Center Drilling | B Corner rounding | G Corner rounding |
| C Thread turning | D Grooving | D Grooving | F V-grooving |
| E Taper turning | F V-grooving | F V-grooving | J Face milling |
| H Engraving | J Face milling | J Face milling | |
| K Drilling & milling a groove | | | |

* Some features produced with a special insert

60° N9MT11T3P60

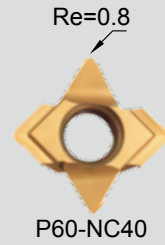

► Inserts >>

• Fully ground spotting insert, for 60 degree spotting and engraving.

NC40: • Universal grade for all unhardened steel and cast iron.

• Each insert has 2 cutting edges.

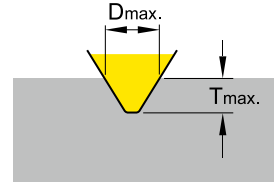

1

NC Spot Drill

Code	Parts No.	Coating	Grade		Dimensions			Dmax.	Tmax.
					L	S	Re		
014204	N9MT11T3P60-NC40	TiN	P35		11	3.97	0.8	6.2	4

► Holder >>

• A single cutting edge design creates higher precision and position when spotting.

• Applications: For spotting, engraving, small grooving on milling machines, machining centers.

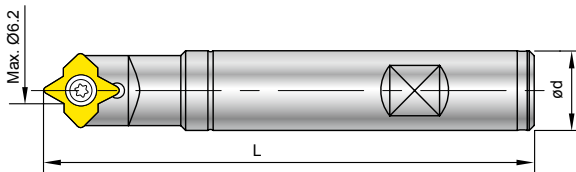

Code	Parts No.	Ød	L	Screw	Key
604002	00-99616-14-12	12	100	NS-35080 2.5 Nm	NK-T15
604004	00-99616-14	16	100		

V9MT0802 / V9MT12T3

60°

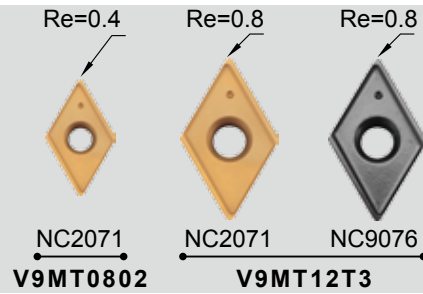
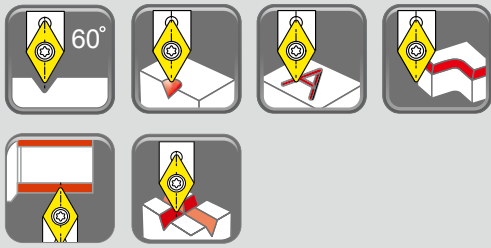

► Inserts >>

- 60 degree indexable spotting insert, Dmax 13mm.
- Special geometry with supporting edges for using in high speed machining.
- Excellent tool for grooving. Saving machining time!

NC2071: • Universal grade for all unhardened steel and cast iron.
• Each insert has 2 cutting edges.

NC9076: • For non-ferrous material such as aluminum, al-alloy, titanium brass, copper and long cutting chip metal.
• Produces excellent surface finish on non-ferrous metal.
• Each insert has 2 cutting edges.

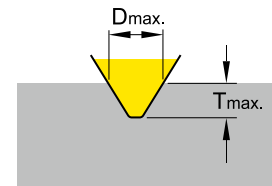

1
NC Spot Drill

Code	Parts No.	Coating	Grade	Re	Dimensions			Dmax.	Tmax.
					L	S	Re		
019201	V9MT0802CT NC2071	TiN	K20F	0.4	8	2.38	0.4	9	7.3
015201	V9MT12T3CT NC2071	TiN	K20F	0.8	12.7	3.97	0.8	13	10.3
015202	V9MT12T3CT NC9076	DLC	K20F	0.8	12.7	3.97	0.8	13	10.3

► Holder >>

- A single cutting edge creates higher precision and position when spotting.
- Applications:
 - Spotting, engraving, grooving and chamfering on milling machines, machining centers.
 - Spotting, facing on CNC Lathes.

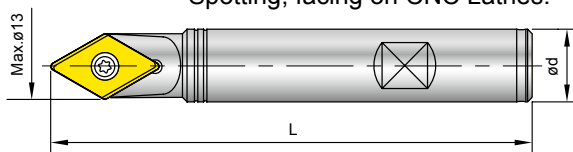

Code	Parts No.	Ød	L	Insert Type	Screw	Key
609001	00-99616-09V (Cylindrical shank)	8	60	V9MT08	*NS-25045 0.9 Nm	NK-T7
605001	00-99616-13V	16	100	V9MT12	NS-35080 2.5 Nm	NK-T15
615001	00-99616-13V-5/8	5/8"	100			

*Torque screwdriver is recommended, see page 6-4.

82°

V0820802 / V08212T3

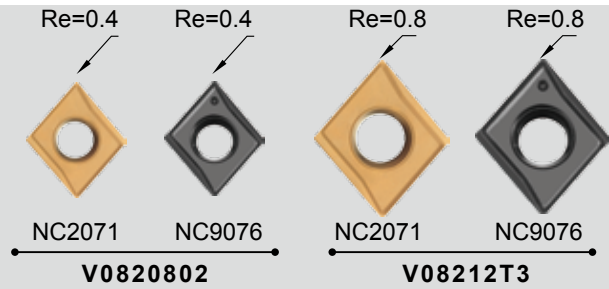
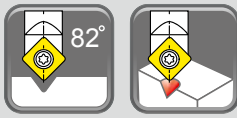

► Inserts >>

- 82 degree indexable spotting insert, Dmax 14mm (0.551")
- Match the geometry of American standard flat head screw hole.
- Special geometry with supporting edges for high speed machining.

NC2071: • Universal grade for all unhardened steel and cast iron.
• Each insert has 2 cutting edges.

NC9076: • For non-ferrous material such as aluminum, al-alloy, titanium brass, copper and long cutting chip metal.
• Produces excellent surface finish on non-ferrous metal.
• Each insert has 2 cutting edges.

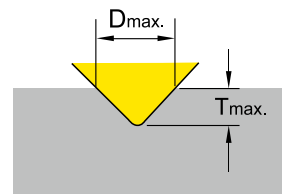

1

NC Spot Drill

Code	Parts No.	Coating	Grade	Image	Dimensions			Dmax.	Tmax.	
					L	S	Re			
0108201	V0820802	NC2071	TiN	K20F		8	2.38	0.4	9 (0.354")	4.8 (0.189")
0108202		NC9076	DLC							
0108211	V08212T3	NC2071	TiN	K20F		12.7	3.97	0.8	14 (0.551")	7.5 (0.295")
0108212		NC9076	DLC							

► Holder >>

- Special cutting edge design gives higher precision and position when spotting.
- Applications : • Spotting, engraving, grooving and chamfering on milling machines, machining centers.
• Spotting, facing on CNC Lathes.

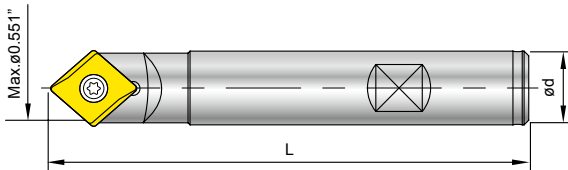

Code	Parts No.	Ød	L	Insert Type	Screw	Key
693001	00-99619-V082-3/8	3/8"	90	V0820802	NS-30055 2.0 Nm	NK-T8
693002	00-99619-V082-5/8	5/8"	100	V08212T3	NS-35080 2.5 Nm	NK-T15

N9MT05T1 / N9MT0602

90°

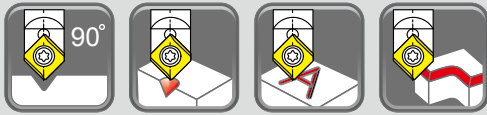

► Inserts >>

- Mini spotting drill with indexable insert, low cutting power required.
 - Especially good for Swiss type automatic lathes and CNC lathes.
- NC2071:**
- Universal grade for all unhardened steel and cast iron.
 - Geometry with supporting edges to stabilize the cutting condition on low power machine.
 - Each insert has 2 cutting edges.
- NC9076:**
- For non-ferrous material such as aluminum, titanium, brass, copper and stainless steel.
 - Produces excellent surface finish on non-ferrous metal.
 - Each insert has 2 cutting edges.

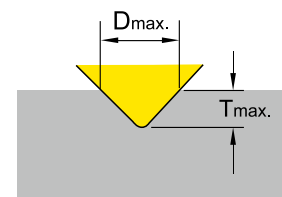

1
NC Spot Drill

Code	Parts No.	Coating	Grade	Re	Dimensions			Dmax.	Tmax.
					L	S	Re		
011201	N9MT05T1CT	TiN	K20F	0.4	5	1.8	6	2.8	
011202		DLC	K20F						
012201	N9MT0602CT	TiN	K20F	0.4	6.35	2.38	8	3.8	
012202		DLC	K20F						

► Holder >>

- Smallest indexable spotting drill holder.
- Single cutting edge design gives higher precision when spotting.
- Applications : • Spotting, engraving, and chamfering on milling machines, machining centers.
- Spotting, facing on CNC Lathes.

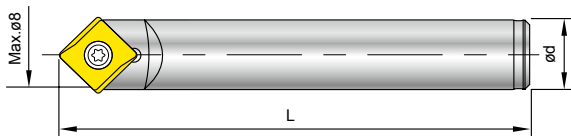

Code	Parts No.	Ød	L	Insert Type	Screw	Key
601001	00-99616-06-6	6	35	N9MT05	*NS-20036 0.6 Nm	NK-T6
601002	00-99616-06-5	5	35			
601003	00-99616-06-6L	6	60			
602001	00-99616-08-8	8	60	N9MT06	*NS-22044 0.9 Nm	NK-T7

Note:601003 is carbide shank holder.

*Torque screwdriver is recommended, see page 6-4.

90° N9MT0802

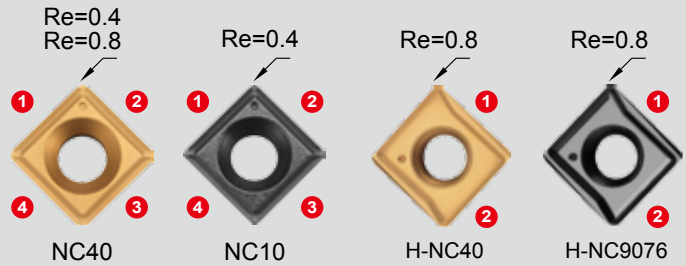
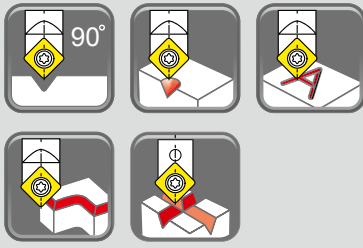

► Inserts >>

- NC40:**
 - General purpose, universal grade for all unhardened steel.
 - Each insert has 4 cutting edges.
- NC10:**
 - High positive angle and fully ground cutting edge and relief angle.
 - Universal grade for non-ferrous metal, cast iron and stainless steel.
 - Each insert has 4 cutting edges.
- H-NC40:**
 - Best choice for spotting application.
 - Special geometry with supporting edges for use in high speed machining.
 - Universal grade for all kind of steel and cast iron.
 - Each insert has 2 cutting edges.
- H-NC9076:**
 - High positive geometry and sharp edge.
 - For non-ferrous material such as aluminum, titanium, brass, copper and long cutting chip metal.
 - Produces excellent surface finish on non-ferrous metal.
 - Each insert has 2 cutting edges.

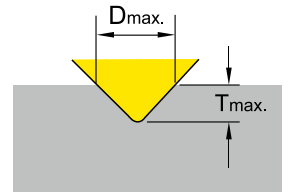

Code	Parts No.	Coating	Grade	Re	Dimensions			Dmax.	Tmax.
					L	S	Re		
013401	N9MT080208CT	NC40	TiN	K20F	8.31	2.38	0.8	10	4.5
013402	N9MT080204CT	NC40	TiN	K20F	8.31	2.38	0.4		
013403		NC10	TiAlN	K20F	8.31	2.38	0.4		
013201	N9MT0802CT2T	H-NC40	TiN	K20F	8.31	2.38	0.8		
013202		H-NC9076	DLC	K20F	8.31	2.38	0.8		

► Holder >>

- Single cutting edge design gives higher precision when spotting.
- Applications :
 - Spotting, engraving, grooving and chamfering on milling machines, machining centers.
 - Spotting, facing, turning on CNC Lathes.

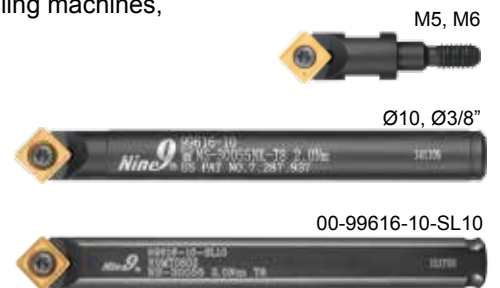
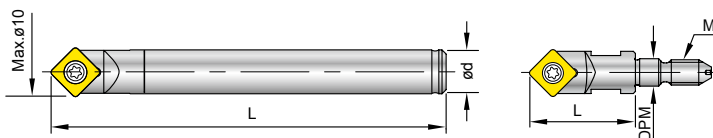

Code	Parts No.	Ød	L	M	DPM	Screw	Key
603001	00-99616-10	10	90	-	-		
603003	00-99616-10-SL10 (Weldon)	10	90	-	-		
613001	00-99616-3/8	3/8"	90	-	-	NS-30055 2.0 Nm	NK-T8
623001	00-99616-10-M5	-	25	M5xP0.8	5.5		
623002	00-99616-10-M6	-	25	M6xP1.0	6.5		

Note: • Balanced type holder is on request.
• Nine9 extension bar for M5, M6 screw fit holder, see page 6-3.

1

NC Spot Drill

N9MT0802

90°



► Single Set >>

- User friendly, each set is fitted with one complimentary insert.

Code	Parts No.	Ød	Total Length	Insert fitted	Dmax.	Tmax.
603101-3401	00-99616-10-02S	10	90	N9MT080208CT-NC40	10	4.5
603101-3403	00-99616-10-02SAL	10	90	N9MT080204CT-NC10	10	4.5

► Starter Package >>

- Selected package for starter who wants to try NC Spot Drill.
- Included one insert on tool holder and five inserts in the pocket.
- Total 6 inserts are equal to 24 spot drills.

Code	Parts No.	Ød	Insert included	Content
603201-3401	00-99616-10-ME6	10	N9MT080208CT-NC40	1 tool holder + 6 inserts + 1 key
603201-3403	00-99616-10-ME6AL	10	N9MT080204CT-NC10	
613201-3401	00-99616-10-IN6	3/8"	N9MT080208CT-NC40	
613201-3403	00-99616-10-IN6AL	3/8"	N9MT080204CT-NC10	



► Comparison >>

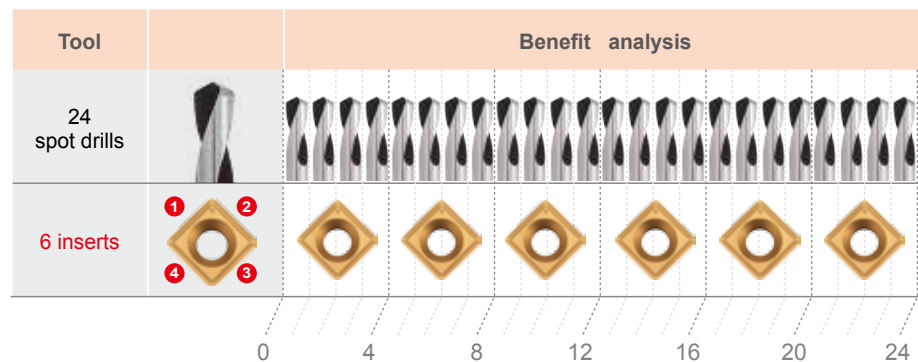

Low Cost! Economy!

6 inserts
 12 inserts
 24 inserts
 ...

=

24 spot drills
 48 spot drills
 96 spot drills
 ...

Note: N9MT080201W Engraving, see page 1-47.



1
NC Spot Drill

90° N9MT11T3

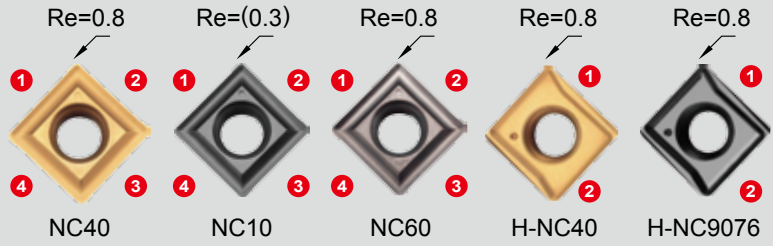
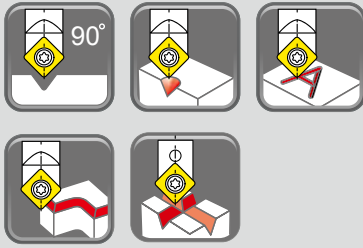

► Inserts >>

- NC40:**
 - Wiper design, universal grade for all unhardened steel.
 - Each insert has 4 cutting edges.
- NC10:**
 - High positive angle and fully ground cutting edge and relief angle.
 - Universal grade for non-ferrous metal, cast iron and stainless steel.
 - Each insert has 4 cutting edges.
- NC60:**
 - Wiper design cermet insert, for hardened steel up to 56 HRC.
 - Each insert has 4 cutting edges.
- H-NC40:**
 - Best choice for spotting application.
 - Special geometry with supporting edges for use in high speed machining.
 - Universal grade for all kind of steel and cast iron.
 - Each insert has 2 cutting edges.
- H-NC9076:**
 - High positive geometry and sharp edge.
 - For non-ferrous material such as aluminum, titanium, brass, copper and long cutting chip metal.
 - Produces excellent surface finish on non-ferrous metal.
 - Each insert has 2 cutting edges.

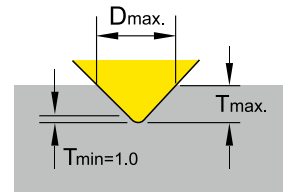

NC40 / Wiper design / NC60

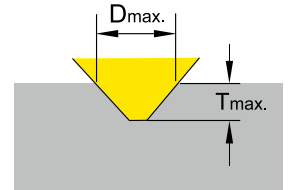

Other grade

Code	Parts No.	Coating	Grade	Re	Dimensions			Dmax.	Tmax.
					L	S	Re		
014401	NC40	TiN	P35	0.8	11.11	3.97	14	7	
014402	NC10	TiAlN	K10F	(0.3)					
014403	NC60	CERMET		0.8					
014202	H-NC40	TiN	K20F	0.8					
014203	H-NC9076	DLC	K20F	0.8					

► Holder >>

- Single cutting edge design gives higher precision when spotting.
- Applications :
 - Spotting, engraving, grooving and chamfering on milling machines, machining centers.
 - Spotting, facing on CNC Lathes.

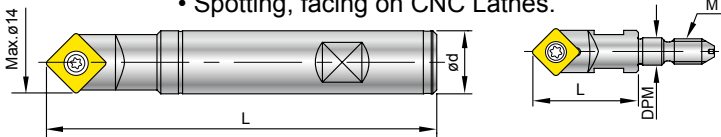

Code	Parts No.	Ød	L	M	DPM	Screw	Key
604002	00-99616-14-12	12	100	-	-		
604004	00-99616-14	16	100	-	-		
604007	00-99616-14-150L	16	150	-	-		
604009	00-99616-14-220L	20	220	-	-	NS-35080 2.5 Nm	NK-T15
614001	00-99616-14-1/2	1/2"	100	-	-		
614002	00-99616-14-5/8	5/8"	100	-	-		
624001	00-99616-14-M8	-	30	M8xP1.25	8.5		

Note: • Balanced type holder is on request.
• Nine9 extension bar for M8 screw fit holder, see page 6-3.

1

NC Spot Drill

N9MT11T3

90°



► Single Set >>

- User friendly, each set is fitted with one complimentary insert.

Code	Parts No.	Ød	Total Length	Insert fitted	Dmax.	Tmax.
604104-4401	00-99616-14-02S	16	100	N9MT11T3CT-NC40	14	7
604104-4402	00-99616-14-02SAL			N9MT11T3CT-NC10	14	7
614102-4401	00-99616-14-5/8-02S	5/8"	100	N9MT11T3CT-NC40	0.551"	0.276"
614102-4402	00-99616-14-5/8-02SAL			N9MT11T3CT-NC10	0.551"	0.276"

1

NC Spot Drill

► Starter Package >>

- Selected package for starter who wants to try NC Spot Drill.
- Included one insert on tool holder and five inserts in the pocket.
- Total 6 inserts are equal to 24 spot drills.

Code	Parts No.	Ød	Insert included	Content
604204-4401	00-99616-14-ME6	16	N9MT11T3CT-NC40	1 tool holder + 6 inserts + 1 key
604204-4402	00-99616-14-ME6AL		N9MT11T3CT-NC10	
614202-4401	00-99616-14-IN6	5/8"	N9MT11T3CT-NC40	
614202-4402	00-99616-14-IN6AL		N9MT11T3CT-NC10	

► Comparison >>

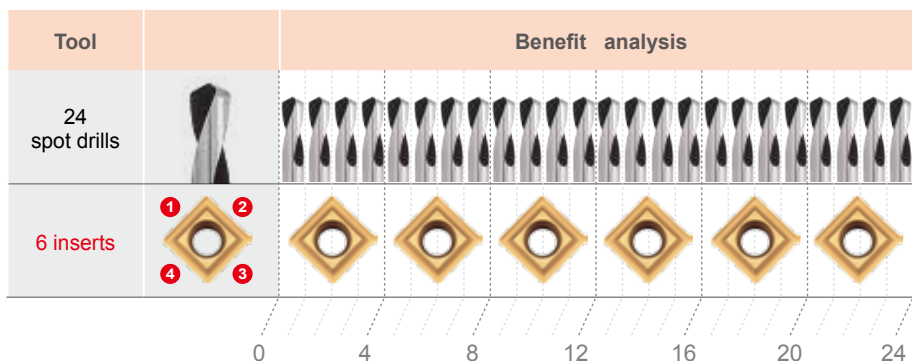

Low Cost! Economy!

1 2
4 3

6 inserts
12 inserts
24 inserts

24 spot drills
48 spot drills
96 spot drills

90° N9MT1704

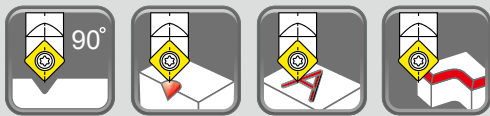

► Inserts >>

- 90 degree indexable spot drill insert, Dmax 22mm.

- NC2071** :
- High positive geometry, fully ground cutting edge and relief angle.
 - Universal grade for all unhardened steel and cast iron.
 - Each insert has 2 cutting edges.

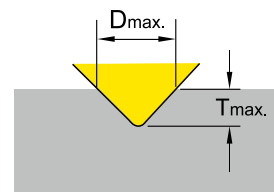

1

NC Spot Drill

Code	Parts No.	Coating	Grade	Re	Dimensions			Dmax.	Tmax.
					L	S	Re		
016201	N9MT1704CT-NC2071	TiN	K20F		17	4.76	1.2	22	10.4

► Holder >>

- Single cutting edge design gives high precision when spotting.
- Applications :
 - Spotting, engraving, grooving and chamfering on milling machines, machining centers.
 - Spotting, facing on CNC Lathes.

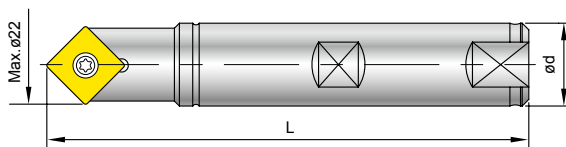

Code	Parts No.	Ød	L	Screw	Key
606001	00-99616-22	20	100	NS-50125 5.5 Nm	NK-T20
606002	00-99616-22-25	25	150		

N9MT220408

90°



NC40

► Inserts >>

- For spotting diameter up to 25mm.
- Fully ground cutting edge and relief angle.

NC40:

- Universal grade for carbon steel, alloy steel and cast iron.
- Each insert has 3 cutting edges.

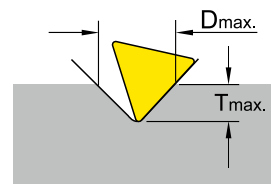

Code	Parts No.	Coating	Grade	Image	Dimensions			Dmax.	Tmax.
					L	S	Re		
017301	N9MT220408CT-NC40	TiN	P35		20.83	4.76	---	25	12.2

1

NC Spot Drill

► Holder >>

- Large spotting diameter with indexable insert.
- Single cutting edge design gives high precision when spotting.
- Applications : spotting and chamfering on milling machine, machining centers.

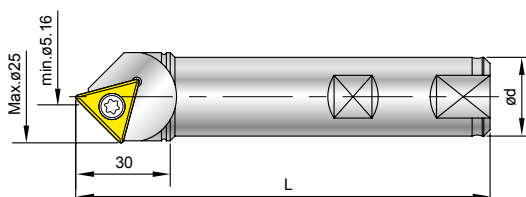

Ø25

Code	Parts No.	Ød	L	Screw	Key
607001	00-99616-25-CT28	25	120	NS-40100 3.5 Nm	NK-T15
617001	00-99616-1-CT28	1"	120		

100°
120°
142°

N9MT11T3CT2T-H

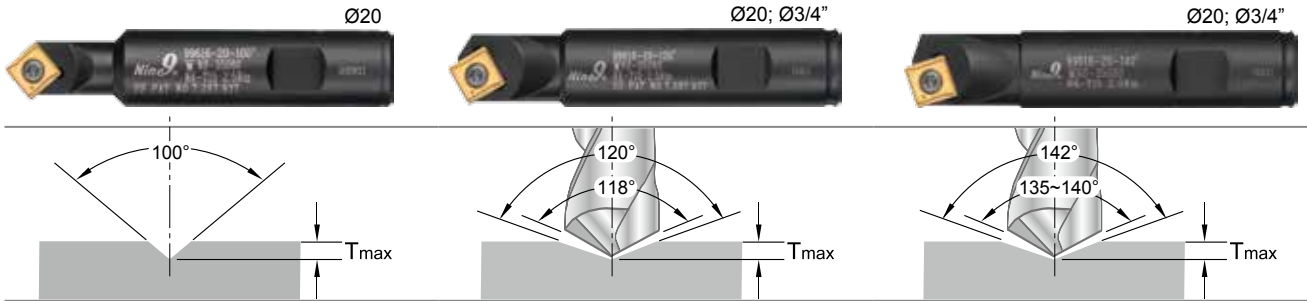
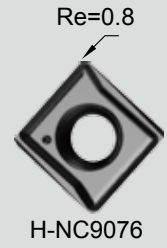

• For aircraft 100° normal rivet hole and screw hole.

• For spotting before drilling by 118° point angle drill.
• 60° chamfering.

• For spotting before drilling by 135°~140° point angle high performance drill.

1

NC Spot Drill

► Inserts >>

H-NC40: • Universal grade for all kind of steel and cast iron.
• Each insert has 2 cutting edges.

H-NC9076: • High positive geometry and sharp edge.
• For non-ferrous material such as aluminum, titanium, brass, copper and long cutting chip metal.
• Produces excellent surface finish when chamfering non-ferrous metal.
• Each insert has 2 cutting edges.

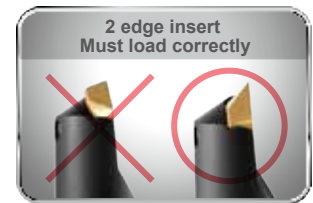

Code	Parts No.	Coating	Grade	Re	Dimensions		
					L	S	Re
014202	H-NC40	TiN	K20F		11	3.97	0.8
014203	H-NC9076	DLC					

► Holder >>

- Indexable insert spotting drill holders for 100°/120°/142° spotting.
- Spotting produces better hole position and geometrically uniform holes.
- Increase tool life of the next drilling operation.

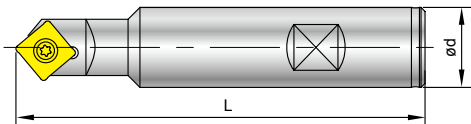

Code	Parts No.	Angle	Ød	L	Screw / Key	Dmax.	Tmax.	
604011	00-99616-20-100	100°	20	100		16	6.3	
604013	00-99616-20-120	120°	20	100		17	4.76	
614003	00-99616-3/4-120	120°	3/4"	100		0.669"	0.187"	
604014	00-99616-20-142	142°	20	100		18.5	3.16	
614004	00-99616-3/4-142	142°	3/4"	100		0.728"	0.124"	

V14208 / V14216

142°

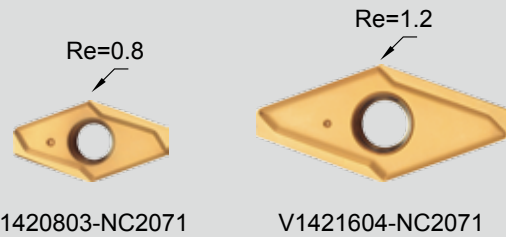
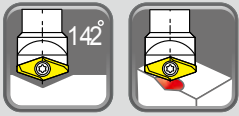

V1420803-NC2071

V1421604-NC2071

► Inserts >>

- For spotting before drilling by 135° - 140° point angle high performance drill.
- 142 degree indexable spotting drills. Dmax 32mm.

- NC2071:**
- High positive geometry, fully ground cutting edge and relief angle.
 - Universal grade for all unhardened steel and cast iron.
 - Each insert has 2 cutting edges.

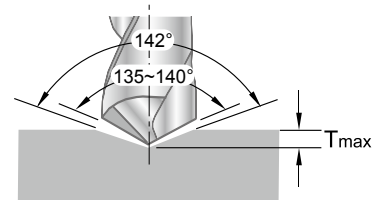

1

NC Spot Drill

Code	Parts No.	Coating	Grade	Dimensions	Dmax.	Tmax.
0114201	V1420803-NC2071	TiN	K20F		16	2.8
0114211	V1421604-NC2071				32	5.5

► Holder >>

- Using spotting first may increase higher speed and feed rate of the after drills.
- Extend your drill life with 142° spotting. Reduce your drilling cost.
- Higher accuracy of positioning and diameter tolerance !

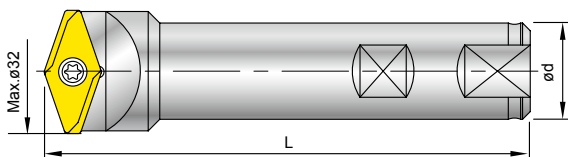

Code	Parts No.	Ød	L	Insert Type	Screw	Key
696001	00-99619-V142-16	16	100	V1420803	NS-30072 2.0 Nm	NK-T9
696002	00-99619-V142-32	25	120	V1421604	NS-50125 5.5 Nm	NK-T20

145°
+
90°

WSP Spotting New Geometry of Spotting Tool

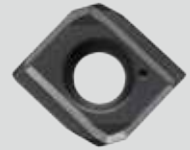

NC2033

► Combined spotting and chamfering 145° + 90° >>

- Reduces process to one operation. Shorten cycle time.
- Use to spot prior to drilling with high performance drills for higher accuracy of hole position.
- Good support spotting process for round parts.

1

NC Spot Drill

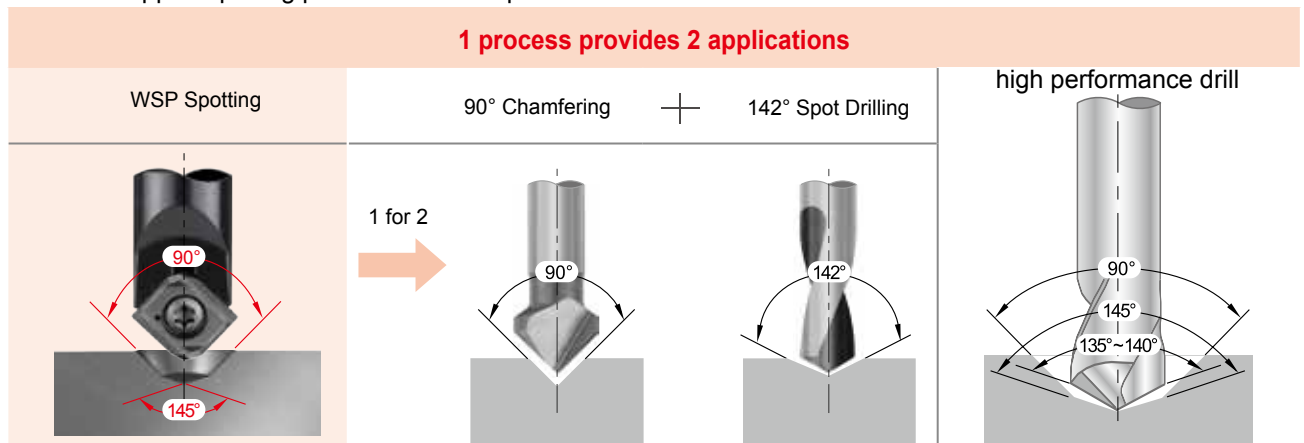

► Inserts >>

- NC2033:**
- Fully ground cutting edge and relief angle.
 - Universal grade for steel and cast iron.
 - Each insert has 2 cutting edges.

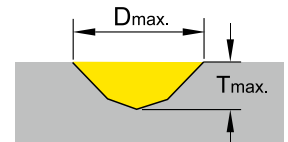

Code	Parts No.	Coating	Grade	Thread Size	*D1±0.05	D2	L2	Dmax.	Tmax.
013203	N9MT0802M04C-NC2033	TiAlN	K20F	M4x0.7	3.30	4.20	0.93	8	2.83
013204	N9MT0802M05C-NC2033			M5x0.8	4.20	5.25	1.14		2.52
013205	N9MT0802M06C-NC2033			M6x1.0	5.00	6.30	1.39		2.24
014219	N9MT11T3M08C-NC2033	TiAlN	K20F	M8x1.25	6.80	8.40	1.81	13	4.11
014220	N9MT11T3M10C-NC2033			M10x1.5	8.50	10.50	2.28		3.53
014221	N9MT11T3UNC25-NC2033	TiAlN	K20F	1/4-20 UNC	5.08	6.70	1.55	13	4.70
014222	N9MT11T3UNC31-NC2033			5/16-18 UNC	6.53	8.40	1.90		4.20
014223	N9MT11T3UNC38-NC2033			3/8-16 UNC	7.94	10.00	2.22		3.72
016205	N9MT1704M12C-NC2033	TiAlN	K20F	M12x1.75	10.25	12.60	2.91	20	6.61
016206	N9MT1704M14C-NC2033			M14x2.0	12.00	14.70	3.22		5.87
016207	N9MT1704M16C-NC2033			M16x2.0	14.00	16.80	3.51		5.11

Note: * D1 refer to the Tap Pre-drilling sizes.

* Technical information, please refer to page 1-25.

WSP Spotting New Geometry of Spotting Tool



► Holder >>

- Utilizes standard **NC Spot Drill** holders.
- Holders and inserts are interchangeable.

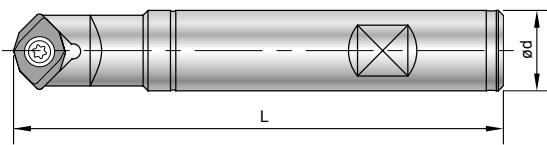

1
NC Spot Drill

Code	Parts No.	Ød	L	Insert Type	Thread Size	Screw	Key
603001	00-99616-10	10	89.08±0.29	N9MT0802	M4~M6	NS-30055 2.0Nm	NK-T8
613001	00-99616-3/8	3/8"					
604004	00-99616-14	16	97.55±0.55	N9MT11T3	M8~M10	NS-35080 2.5Nm	NK-T15
614002	00-99616-14-5/8	5/8"					
606001	00-99616-22	20	96.24±0.64	N9MT1704	M12~M16	NS-50125 5.5Nm	NK-T20
616001	00-99616-22-3/4	3/4"					

► Example >>

- The recommended chamfering is 5% of the nominal diameter of the thread, for example 6.3 mm for M6 thread.
- If you need larger chamfer, it can be calculated the required depth of spotting. (see page 1-27)

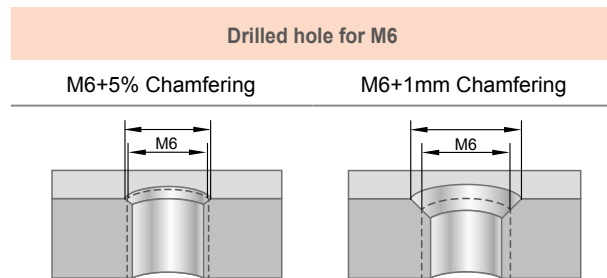

► Comparison >>

Step Drill	Drill + Spotting	WSP Spotting + Drill
<ul style="list-style-type: none"> • Tool cost is high • Shorter tool life • Can't drill directly from solid on round parts. Bad position accuracy. 	<ul style="list-style-type: none"> • Longer drilling time • Guided at the weakest corner of drill • Shorter tool life 	<ul style="list-style-type: none"> • Shorter drilling time • Guided at the strongest corner of drill • Longer tool life • Good position accuracy



Corner Rounding >> Type of RC

Various corner radius inserts can fit on same holder
Carbide insert can stand very long tool life
Produces smooth and excellent surface finish on workpiece.

1

Features

Corner Rounding

- Each insert has 2 cutting edges.
- Combination corner rounding and 45° chamfering application on same insert.
- Higher cutting speed and feed rate.
- Very small X offset, good for contour chamfering.
- Utilizes standard NC Spot Drill holders 99616-06, 99616-14 & 99616-22.

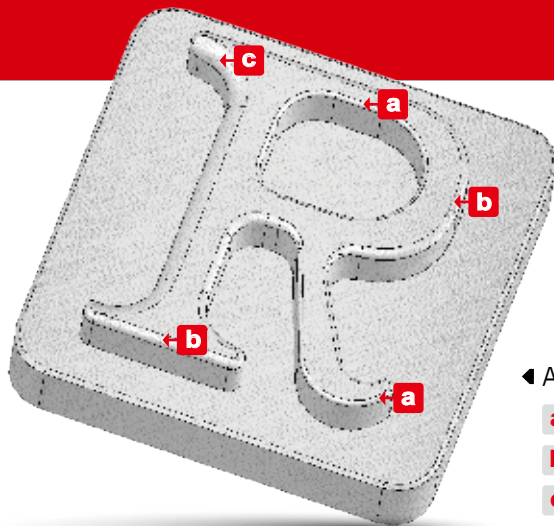
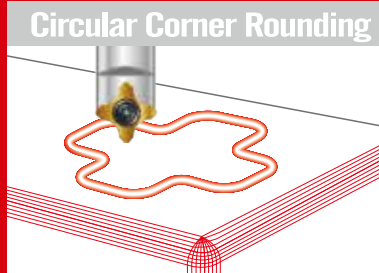
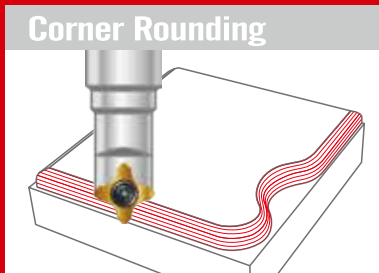

Applications

- a** Radius 0.5
- b** Radius 1.0
- c** Radius 2.0



N9MT05T1RC

RC



RC0.5~RC1.0
All are interchangeable on same holder



NC2071

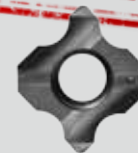

NC9036

▶ Inserts >>

- Various corner radius inserts can fit on same holder.
- Very small X offset 1.25mm for radius 0.5, the small x offset allows for profiling in small corners.

- NC2071:**
- Universal grade for all unhardened steel and cast iron.
 - Inserts are CNC ground for precision radius location.
 - Each insert has 2 cutting edges.

- NC9036:**
- For non-ferrous material such as aluminum, acrylic, titanium, brass, copper and stainless steel.
 - High positive geometry and sharp edge produces excellent surface finish.
 - Each insert has 2 cutting edges.

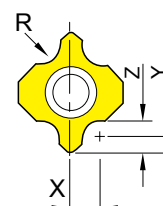

1

Corner Rounding

Insert Radius	Code	Parts No.	Coating	Grade	offset				Dimensions		
					X	Y	Z		L	S	
0.5	011203	N9MT05T1RC05	NC2071	TiN	K20F	1.25	0.75	1.25		5	1.8
	011206		NC9036	DLC							
0.75	011204	N9MT05T1RC075	NC2071	TiN	K20F	1.50	0.75	1.50			
	011207		NC9036	DLC							
1.0	011205	N9MT05T1RC10	NC2071	TiN	K20F	1.75	0.75	1.75			
	011208		NC9036	DLC							

▶ Holder >>

- For corner rounding using **NC Spot Drill** shank.

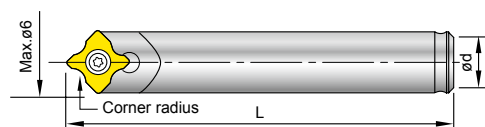

Ø5



Ø6



Ø6

Code	Parts No.	Ød	L	Screw	Key
601001	00-99616-06-6	6	35	*NS-20036 0.6 Nm	NK-T6
601002	00-99616-06-5	5	35		
601003	00-99616-06-6L	6	60		

Note: 601003 is carbide shank holder.

*Torque screwdriver is recommended, see page 6-4.



RC1.0~RC3.0

All are interchangeable on same holder



NC40

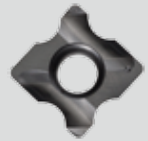

NC9036

► Inserts >>

- Higher cutting speed and feed rate.
- Combination corner rounding and 45° chamfering application on same insert.
- Various corner radius inserts can fit on same holder.

NC40:

- Universal grade for all unhardened steel and cast iron.
- Inserts are CNC ground for precision radius location.
- Each insert has 2 cutting edges.

NC9036:

- For non-ferrous material such as aluminum, acrylic, titanium, brass, copper and stainless steel.
- High positive geometry and sharp edge produces excellent surface finish.
- Each insert has 2 cutting edges.

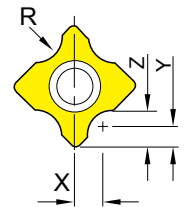

1

Corner Rounding

Insert Radius	Code	Parts No.		Coating	Grade	offset			Dimensions			
						X	Y	Z	L	S		
1.0	014209	N9MT11T3RC10	NC40	TiN	K20F	2.75	1.5	2.5	11.11	3.97		
	014224		NC9036	DLC								
1.5	014210	N9MT11T3RC15	NC40	TiN	K20F	3.25	1.5	3				
	014225		NC9036	DLC								
2.0	014211	N9MT11T3RC20	NC40	TiN	K20F	3.75	1.5	3.5				
	014226		NC9036	DLC								
2.5	014212	N9MT11T3RC25	NC40	TiN	K20F	4.25	1.5	4				
	014227		NC9036	DLC								
3.0	014213	N9MT11T3RC30	NC40	TiN	K20F	4.75	1.4	4.4				
	014228		NC9036	DLC								
1/64	014214	N9MT11T3RC1/64	NC40	TiN	K20F	0.086"	0.059"	0.0747"			0.437"	0.156"
	014229		NC9036	DLC								
1/32	014215	N9MT11T3RC1/32	NC40	TiN	K20F	0.101"	0.059"	0.090"				
	014230		NC9036	DLC								
1/16	014216	N9MT11T3RC1/16	NC40	TiN	K20F	0.133"	0.059"	0.122"				
	014231		NC9036	DLC								
3/32	014217	N9MT11T3RC3/32	NC40	TiN	K20F	0.164"	0.059"	0.153"				
	014232		NC9036	DLC								
1/8	014218	N9MT11T3RC 1/8	NC40	TiN	K20F	0.199"	0.055"	0.180"				
	014233		NC9036	DLC								

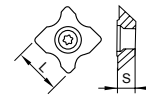

► Holder >>

- For corner rounding using **NC Spot Drill** shank.

Code	Parts No.	Ød	L	Screw/ Key
604002	00-99616-14-12	12	100	NS-35080 2.5 Nm
604004	00-99616-14	16		
614001	00-99616-14-1/2	1/2"	100	NK-T15
614002	00-99616-14-5/8	5/8"		

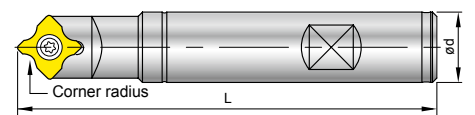

Ø12, Ø16



N9MT1704RC

RC



RC4.0~RC6.0
All are interchangeable
on same holder



NC2071

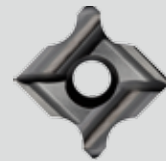

NC9036

► Inserts >>

- Higher cutting speed and feed rate.
- Combination corner rounding and 45° chamfering application on same insert.
- Various corner radius inserts can fit on same holder.

NC2071:

- Universal grade for all unhardened steel and cast iron.
- Inserts are CNC ground for precision radius location.
- Each insert has 2 cutting edges.

NC9036:

- For non-ferrous material such as aluminum, acrylic, titanium, brass, copper and stainless steel.
- High positive geometry and sharp edge produces excellent surface finish.
- Each insert has 2 cutting edges.

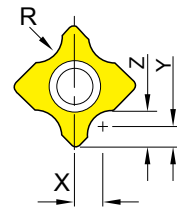

1

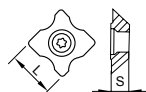

Corner Rounding

Corner radius(R)	Code	Parts No.	Coating	Grade	offset				Dimensions		
					X	Y	Z		L	S	
4.0	016202	N9MT1704RC40	NC2071	TiN	K20F	6.15	2	6			
	016208		NC9036	DLC							
5.0	016203	N9MT1704RC50	NC2071	TiN	K20F	7.1	2	7		17	4.76
	016209		NC9036	DLC							
6.0	016204	N9MT1704RC60	NC2071	TiN	K20F	8.1	2	8			
	016210		NC9036	DLC							

► Holder >>

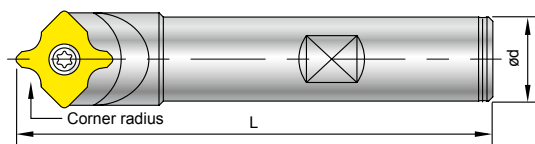
- For corner rounding using **NC Spot Drill** shank.
- Good for small work pieces, which need large corner rounding.



Code	Parts No.	Ød	L	Screw	Key
606001	00-99616-22	20	100	 NS-50125 5.5 Nm	 NK-T20
606002	00-99616-22-25	25	150		



Corner Rounding >> Type of R

Various corner radius inserts can fit on same holder
Carbide insert can stand very long tool life
Produces smooth and excellent surface finish on workpiece.

1

Features

Corner Rounding

- Each insert has 4 cutting edges.
- R1.0 ~ R3.0 inserts are interchangeable on same holder.
- For front and back chamfering.
- Tool offset can be set after measuring tool length by tool presetter or Z-Zero Setter.
- Inserts are CNC ground for precision radius and location.
- Optimizes the tool performance and reduces the cutting time.

Front & Back
Corner Rounding

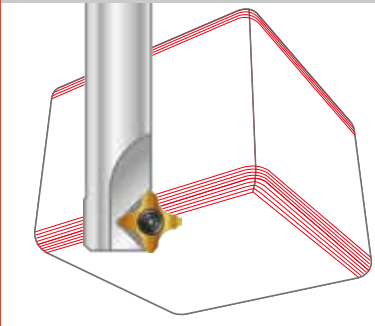

Back
Circular Corner Rounding

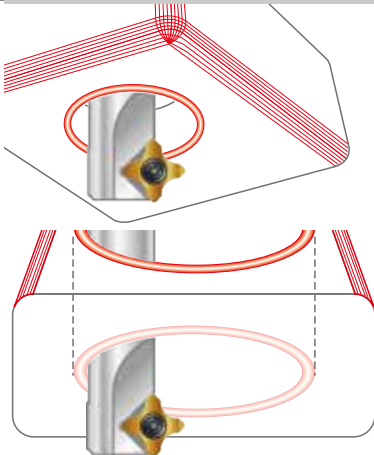

N9MT11T3R

R



R1.0~R3.0
All are interchangeable on same holder



▶ Inserts >>

- For front and back corner rounding.
- Various corner radius inserts can fit on same holder.
- Coated carbide inserts for excellent tool life.
- Each insert has 4 cutting edges.

NC2071: • Universal grade for all unhardened steel and cast iron.
• Inserts are CNC ground for precision radius location.

Corner radius(R)	Code	Parts No.	Coating	Grade		Dimensions	
						L	S
1.0	014404	N9MT11T3R10-NC2071	TiN	P35		11.11	3.97
1.5	014405	N9MT11T3R15-NC2071	TiN	P35			
2.0	014406	N9MT11T3R20-NC2071	TiN	P35			
2.5	014407	N9MT11T3R25-NC2071	TiN	P35			
3.0	014408	N9MT11T3R30-NC2071	TiN	P35			

1

Corner Rounding

▶ Holder >>

- Center of radius of each tool is dedicated.
- Tool offset can be set after measuring tool length by tool presetter or Z-Zero Setter.

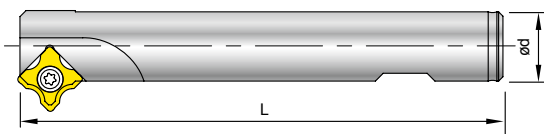

Code	Parts No.	Ød	L	Z	Screw	Key
604015	00-99616-16-25R	16	100	1	NS-35080 2.5 Nm	NK-T15
604019	00-99616-16-30R	16	120	1		
604020	00-99616-25-40R	25	150	4		

▶ More >>

- Also can fit with N9MT11T308LA inserts for front and back chamfering. (Please see page 1-24)

R N9MT11T3R



▶ Cutting Position >>

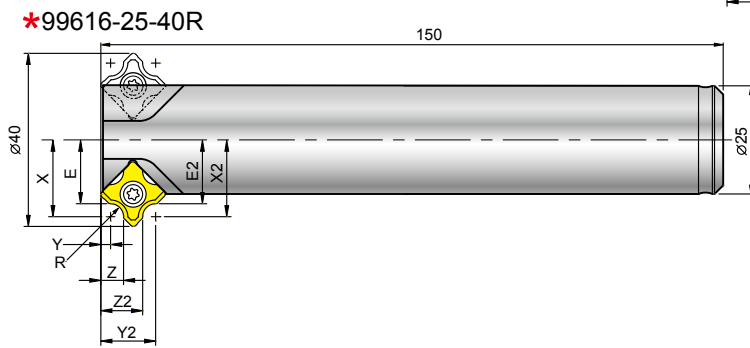
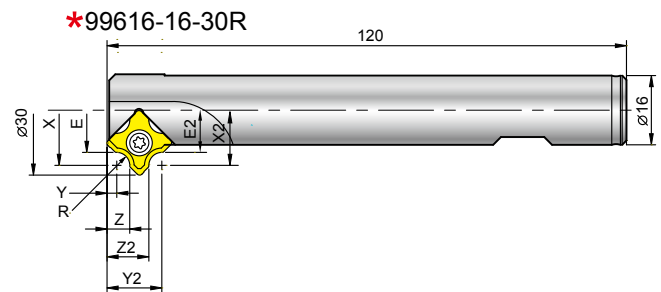
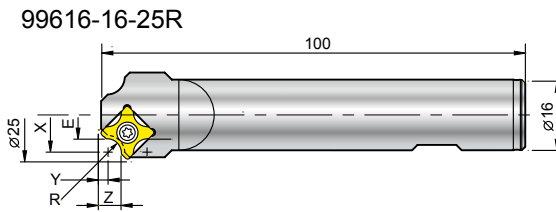

99616-16-30R & 99616-25-40R
 *For front and back corner rounding.
 *Eliminates 2nd operation or deburring time.

1

Corner Rounding

Insert Radius	Holder	Front Chamfering				Back Chamfering				⊕ Z
		E	X	Y	Z	E2	X2	Y2	Z2	
R1.0	00-99616-16-25R	8.25	9.25	3.25	4.25	—	—	—	—	1
	00-99616-16-30R	10.75	11.75	3.25	4.25	10.75	11.75	11.65	10.65	1
	00-99616-25-40R	15.75	16.75	3.25	4.25	15.75	16.75	11.65	10.65	4
R1.5	00-99616-16-25R	8	9.5	3	4.5	—	—	—	—	1
	00-99616-16-30R	10.5	12	3	4.5	10.5	12	11.9	10.4	1
	00-99616-25-40R	15.5	17	3	4.5	15.5	17	11.9	10.4	4
R2.0	00-99616-16-25R	7.75	9.75	2.75	4.75	—	—	—	—	1
	00-99616-16-30R	10.25	12.25	2.75	4.75	10.25	12.25	12.15	10.15	1
	00-99616-25-40R	15.25	17.25	2.75	4.75	15.25	17.25	12.15	10.15	4
R2.5	00-99616-16-25R	7.5	10	2.5	5	—	—	—	—	1
	00-99616-16-30R	10	12.5	2.5	5	10	12.5	12.4	9.9	1
	00-99616-25-40R	15	17.5	2.5	5	15	17.5	12.4	9.9	4
R3.0	00-99616-16-25R	7.25	10.25	2.25	5.25	—	—	—	—	1
	00-99616-16-30R	9.75	12.75	2.25	5.25	9.75	12.75	12.65	9.65	1
	00-99616-25-40R	14.75	17.75	2.25	5.25	14.75	17.75	12.65	9.65	4

N9MT11T308LA 45° Chamfering Tool

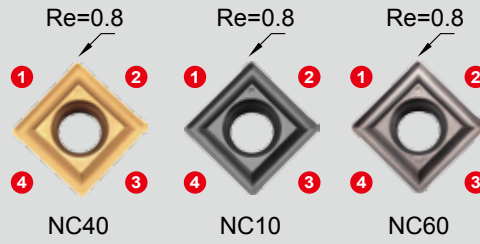

▶ Inserts >>

- NC40:**
 - General purpose, universal grade for all unhardened steel.
 - Each insert has 4 cutting edges.
- NC10:**
 - High positive angle and fully ground cutting edge and relief angle.
 - Universal grade for Al, Al-alloy, non-ferrous metal, cast iron and stainless steel.
 - Each insert has 4 cutting edges.
- NC60:**
 - Cermet insert, for hardened steel up to 56 HRC .
 - Each insert has 4 cutting edges.

Code	Parts No.	Coating	Grade	Dimensions	L	S	Re
014409	N9MT11T308LA	NC40	TiN	P35	11.11	3.97	0.8
014410		NC10	TiAN	K10F			
014411		NC60	Cermet				

▶ Holder >>

- 00-99616-28 can be applied for machining back chamfering and side grooving.

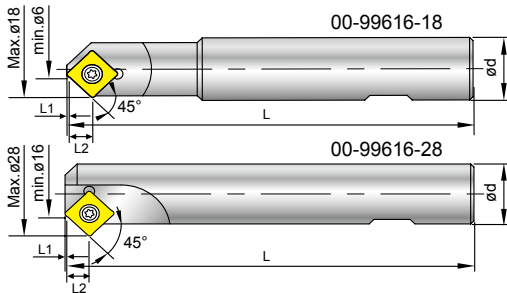

Code	Parts No.	Chamfering	Ød	L	L1	L2	Z	Insert type	Screw / Key
604017	00-99616-18	Ø6-Ø18	20	120	1.15	7.55	1	N9MT11T308LA	NS-35080 2.5 Nm
604018	00-99616-28	Ø16-Ø28	20	120	1.15	7.55	1		NK-T15

▶ Example >>

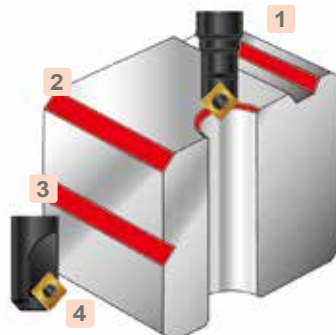
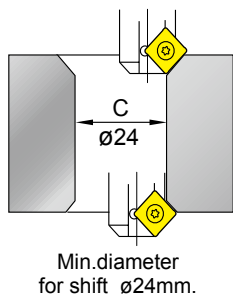
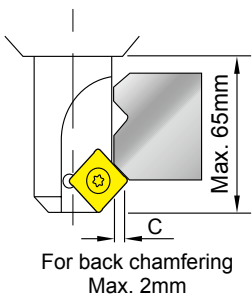

Action	
1	External and internal chamfering
2	Side chamfering
3	Side grooving
4	Back chamfering

1
Corner Rounding - LA

Cutting Data

► Diameter / Depth Chart and Speed / Feed Rate Calculation of NC Spot Drill

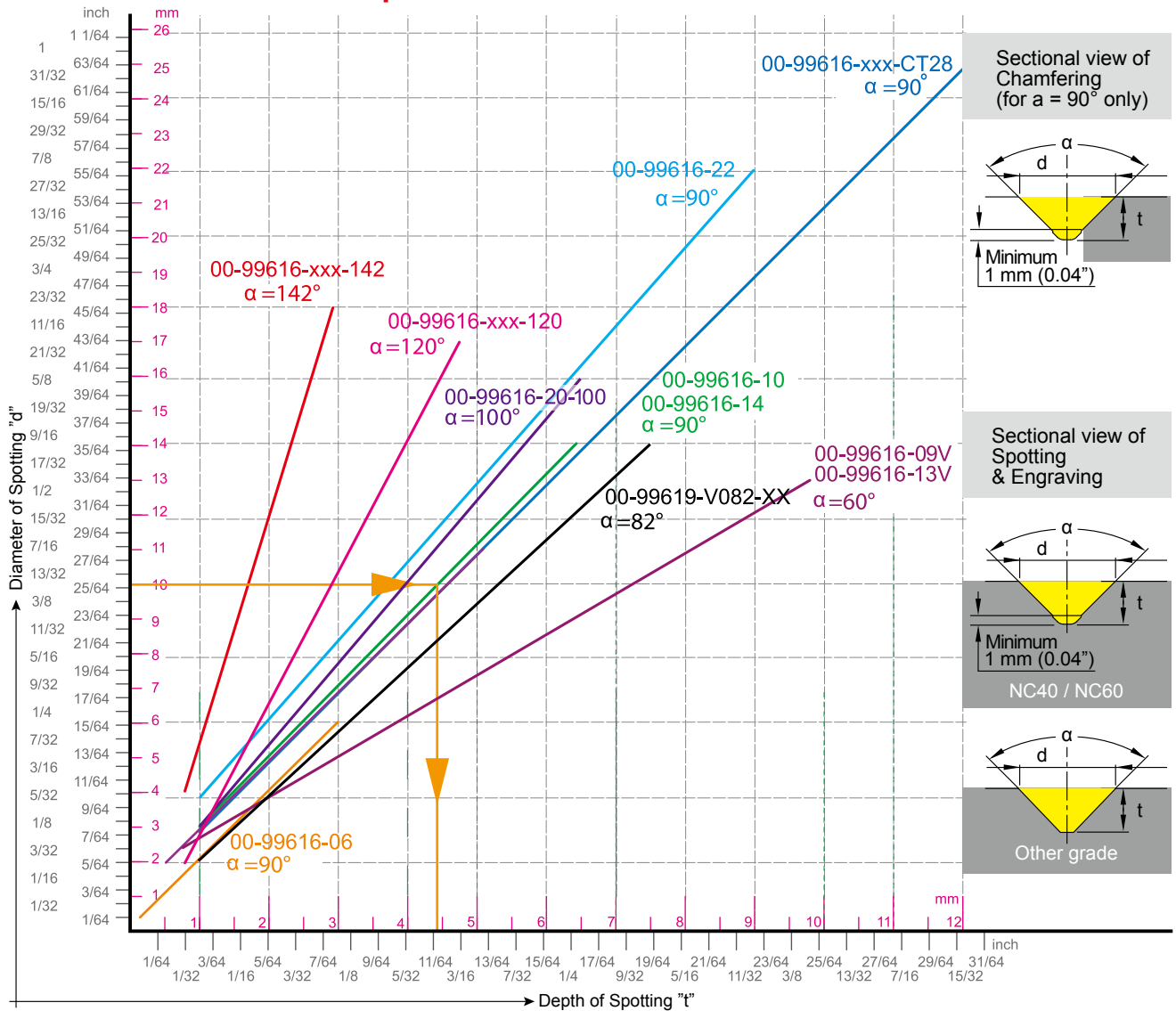

► Instruction of Use >>

1. From Spot diameter "d" to get drill depth "t".
2. Point angle "α" is determined by which tool holder you use.
3. From "d" draw a horizontal line to get intersection of the line by point angle "α".
4. From the intersection draw a vertical line to the bottom to have depth of spotting "t". "t" is the drill depth of the NC program.
5. The sectional view of spotting will depend on the shape of insert, NC40 and other grades of inserts have different sectional view.
6. For chamfering, do not use tip of insert, 1mm(0.04") minimum clearance is required for a smooth surface finish.

► Calculate spindle speed and feed rate >>

1. Using your "d" value and cutting speed Vc from the data sheet, calculate spindle speed "S"(RPM).
2. "F" feed rate per minute $F = f \times S = \text{RPM} \times \text{IPR}$

Metric		Inch	
$S = \frac{Vc \times 1000}{\pi \times d}$	d = diameter -mm	$S = \frac{(3.82 \times \text{SFM})}{d}$	d = diameter -inch
$F = S \times f$	S = Spindle Speed -r.p.m.	$F = f \times S$	S = Spindle Speed -r.p.m.
	Vc = Cutting Speed -m/min.		SFM = Surface Speed -ft./min. $Vc \text{ (m/min.)} \times 3.28$
	f = mm/rev.		f = IPR = inch/rev.
	F = mm/min.		F = inch/min.

1

NC Spot Drill

Cutting Data

► N9MT-CT >> Insert Multi-function

Determine spindle speed and feed rate:

- Choose spotting depth to decide spotting diameter according to the Diameter/Depth chart on page 1-25.
- The spindle speed should be calculated by the maximum diameter of spotting, chamfering and grooving.

Spotting	Work Material	Vc (m/min)	f (mm/rev.)	Grade of Insert
	Carbon steel	150~250	0.05~0.10	NC40, NC2071
	Alloy steel	100~200	0.04~0.08	NC40, NC2071
	Stainless steel	65~125	0.03~0.06	NC10, NC60, H-NC40, NC2071
	Casting iron	80~150	0.05~0.10	H-NC40, NC10, NC2071
	Non-ferrous metal (Al, Cu)	150~300	0.05~0.10	NC10, NC9076, NC2071
	Ti, Ti-alloy	40~80	0.03~0.08	NC9076
	Hardened steel 40~56 HRC	30~60	0.03~0.08	NC60

* For technical construction reasons, the insert is not located on the center of the holder.

* Inserts with supporting edges can increase feed rate 50%.

Chamfering	Work Material	Vc (m/min)	f (mm/rev.)	Grade of Insert
	Carbon steel	150~320	0.15~0.24	NC40, NC2071
	Alloy steel	100~250	0.12~0.20	NC40, NC2071
	Stainless steel	65~125	0.1~0.20	NC10, NC60, H-NC40, NC2071
	Casting iron	150~250	0.15~0.25	H-NC40, NC10, NC2071
	Non-ferrous metal (Al, Cu)	150~320	0.15~0.25	NC10, NC9076, NC2071
	Ti, Ti-alloy	40~80	0.03~0.08	NC9076
	Hardened steel 40~56 HRC	30~60	0.03~0.08	NC60

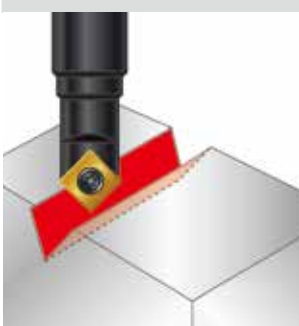
Grooving	Work Material	Vc (m/min)	f (mm/rev.)	Grade of Insert
	Carbon steel	150~250	0.05~0.10	NC40, NC2071
	Alloy steel	100~200	0.04~0.08	NC40, NC2071
	Stainless steel	65~125	0.03~0.06	NC10, NC60, H-NC40, NC2071
	Casting iron	80~150	0.05~0.08	H-NC40, NC10, NC2071
	Non-ferrous metal (Al, Cu)	150~320	0.05~0.08	NC10, NC9076, NC2071
	Ti, Ti-alloy	40~80	0.03~0.08	NC9076
	Hardened steel 40~56 HRC	30~60	0.03~0.08	NC60

1
NC Spot Drill

Cutting Data

► WSP Spotting >> 145°+90° W Spotting

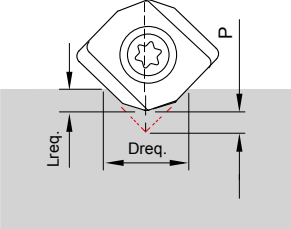
WSP spotting	Formula										
	$P =$ distance of theoretical intersection point to tip of insert.										
	$0.5 =$ fixed factor for calculation										
	$L_{req.} = D_{req.} \times 0.5 - P$ $L_{req.} =$ required drilling depth										
	$D_{req.} =$ required diameter										
	M4	M5	M6	M8	M10	M12	M14	M16	1/4-20 UNC	5/16-18 UNC	3/8-16 UNC
$P =$	1.17	1.48	1.76	2.39	2.97	3.59	4.19	4.88	1.80	2.30	2.78

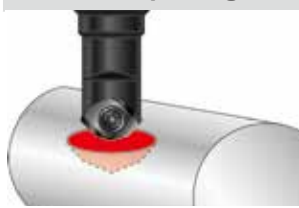
WSP spotting	Work Material	Vc (m/min)	f (mm/rev.)
	Carbon steel	150 ~ 300	0.05 ~ 0.15
	Alloy steel	120 ~ 250	0.05 ~ 0.10
	Stainless steel	80 ~ 150	0.04 ~ 0.08
	Casting iron	100 ~ 200	0.05 ~ 0.10

1

Corner Rounding

► N9MT-RC Insert >> Corner Rounding

Determine spindle speed and feed:

To decide running speed of the tools and feed rate, please calculate spindle speed and feed rate according to the following formula and cutting data:

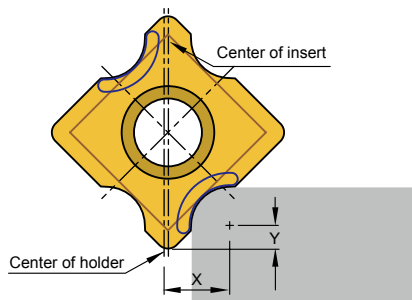
Corner Rounding	Calculate spindle speed	
	$d = 2 \times X$ mm	$d =$ diameter of the tool for calculation purpose
	$S = \frac{Vc \times 1000}{d \times \pi}$ r.p.m.	$X =$ tool radius offset (ref. page 1-18~20 for RC inserts)
	$F = S \times f$ mm/min.	$Vc =$ Cutting Speed -m/min.
		$S =$ Spindle Speed -r.p.m.
		$F =$ mm/min.
		$f =$ mm/rev.
	Calculate tool length offset on machining center	
	$TL = TL' - Y,$	$X =$ tool radius offset (ref. page 1-18~20 for RC inserts)
	$H = X$	$Y =$ distance to the center of radius. (ref. page 1-18~20 for RC inserts)
		$TL' =$ tool length
		$TL =$ tool length offset.
		$H =$ tool radius offset

RC Insert	Work Material	Vc (m/min)	f (mm/rev.)	Grade of Insert
	Carbon steel	150~320	0.05~0.10	NC40, NC2071
	Alloy steel	100~250	0.05~0.10	NC40, NC2071
	High alloy steel	80~150	0.04~0.08	NC40, NC2071
	Stainless steel	65~125	0.05~0.10	NC9036
	Casting iron	150~250	0.05~0.10	NC40, NC2071
	Aluminum, Al-alloy Si < 12%	150~320	0.05~0.10	NC9036
	Al-alloy Si > 12%	100~300	0.05~0.10	NC9036
	Cu	200~250	0.05~0.10	NC9036
	Brass and Bronze	150~250	0.05~0.10	NC9036
	Ti, Ti-alloy	40-80	0.03~0.08	NC9036

Cutting Data

▶ N9MT-R Insert >> Corner Rounding (4 cutting edges)

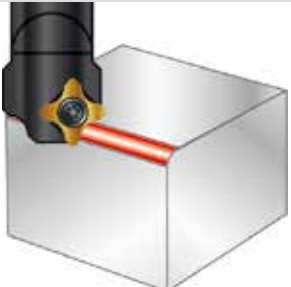
R Insert	Work Material	Vc (m/min)	f (mm/rev.)	Grade of Insert
	Carbon steel	150~320	0.05~0.10	NC2071
	Alloy steel	100~250	0.04~0.08	NC2071
	High alloy steel	60~80	0.03~0.06	NC2071
	Casting iron	150~250	0.05~0.10	NC2071

1

Corner Rounding

▶ LA Insert >> 45° Chamfering

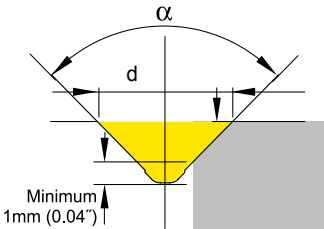
45° Chamfering	Formula
	$\alpha =$ point angle 90°
	$S = \frac{Vc \times 1000}{d \times \pi}$ r.p.m.
	$d =$ effective diameter
	$Vc =$ cutting speed-m/min.or ft/min.
	$F = S \times f$ mm/min.
	$S =$ Spindle speed
	$f =$ feed per rev.-mm/rev.

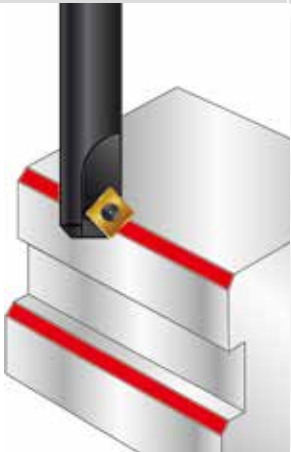
45° Chamfering	Work Material	Vc (m/min)	f (mm/rev.)	Grade of Insert
	Carbon steel	150-320	0.05~0.10	NC40
	Alloy steel	100-250	0.04~0.08	NC40
	High alloy steel	60-80	0.03~0.06	NC40
	Stainless steel	65-125	0.03~0.06	NC10
	Casting iron	150-250	0.05~0.10	NC10, NC40
	Aluminum, Al-alloy Si < 12%	150-320	0.05~0.10	NC10
	Al-alloy Si >12%	100-300	0.05~0.10	NC10
	Cu	200-250	0.05~0.10	NC10
	Brass and Bronze	150-250	0.05~0.10	NC10
	Hardened steel 40~56 HRC	60-80	0.05~0.10	NC60



Center Drill >> i-Center®

The “ i-Center ” is a trademark of Nine9, the developer of the first indexable center drill in the world.(Patented)
Offering an indexable insert system for the 1st time, Nine9’s “i-Center ” design improves your process performance.

1

Features

i-Center

World's first indexable center drill
Shortens set up and center drilling time
Increases tool life and reduces tooling costs

▶ High Speed, High Feed Rate

- The special ground insert and rigid holder design facilitate high performance speed and feed rates. For example, drilling alloy steel at 6000 rpm and feed rate of 600 mm/min. (0.1 mm/rev.)

▶ Excellent Repeatability

- The positioning repeatability of the insert is within 0.02 mm (.0008”) in radial direction, thus ensuring conformity to any national standards.

▶ Easy Tool Length Setting

- The axial position accuracy of the insert is 0.05 mm (.002”). It is not necessary to reset the tool length when changing the insert or cutting edge.



▲ High pressure coolant can be supplied through center directly to tip of center drill insert.

▶ Extended Tool Life

- Coolant can be supplied through the center of the holder to increase performance and extend tool life.
- Insert geometry, grades and coating process are specifically engineered for centering applications.





NC2033



NC5074 (IC08)

DIN 332 Form R

Ø1.0~Ø10

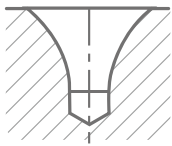

DIN 332 Form A + B

Ø1.0~Ø10

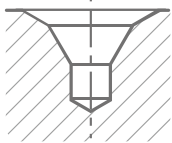

DIN 332 Form A

Ø2.0~Ø2.5

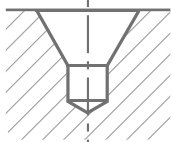

ANSI 60°

#2.0~#10

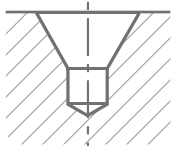

*** C Type**

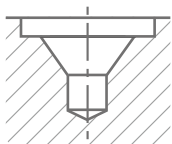

*** F Type**

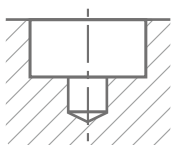

* special on request

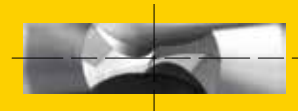

▲ 2 cutting flutes design

Inserts:

- 2 cutting flutes design same as carbide center drill for high performance speed and feed rate.
- Each insert has 2 cutting edges.

NC2033:

- K20F grade, TiAlN coated, for carbon steel, alloy steel, high alloy steel and cast iron.

NC5074:

- P40 grade, Helica coated, design for small diameter center drill (IC08 inserts).



▼ Excellent repeatability by insert type. No need tool length re-setting while changing insert or cutting edge.

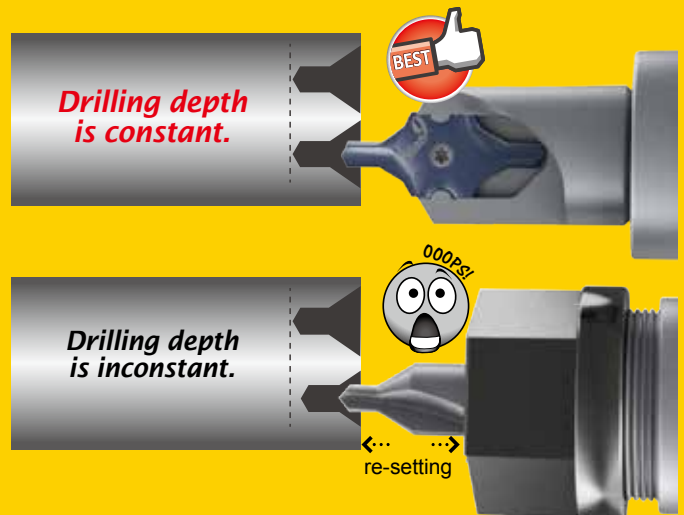

Insert of Indexable Center Drill

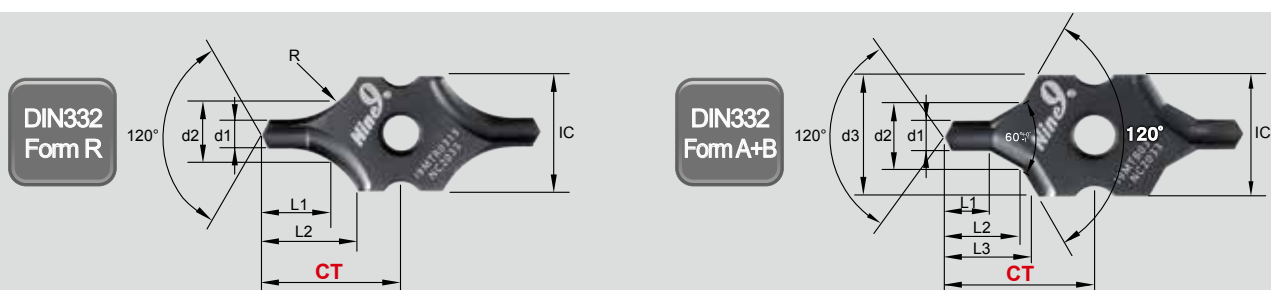

► For DIN332 Form R Center Hole >>

IC	Code	Parts No.	Coating	Grade	d1	d2	L1	L2	R	CT ±0.025	
08	032211	I9MT08T1R0100-NC5074	Helica	P40	1.00	+ 0.14 0	2.12	2.16	4.14	2.8	7.55
	032212	I9MT08T1R0125-NC5074			1.25		2.65	2.74	4.64	3.5	7.90
	032213	I9MT08T1R0160-NC5074			1.60		3.35	3.45	5.13	4.5	8.40
	032214	I9MT08T1R0200-NC5074			2.00		4.25	4.45	6.08	5.65	9.10
12	033201	I9MT12T2R0200-NC2033	TiAlN	K20F	2.00	+ 0.14 0	4.25	4.45	6.64	5.65	11.73
	033202	I9MT12T2R0250-NC2033			2.50		5.3	5.59	8.11	7.15	13.00
	033203	I9MT12T2R0315-NC2033			3.15		6.7	7.21	9.63	9.0	14.00
16	034201	I9MT1603R0400-NC2033			4.00	+ 0.18 0	8.5	9.06	12.23	11.0	19.40
	034202	I9MT1603R0500-NC2033			5.00		10.6	11.45	14.2	14.0	19.40
20	035201	I9MT2004R0630-NC2033			6.30	+ 0.22 0	13.2	14.63	18.2	18.0	28.40
	035202	I9MT2004R0800-NC2033	8.00	17.0	18.63		20.44	22.5	28.30		
25	036201	I9MT2506R1000-NC2033	10.00	21.2	23.51		25.8	28.0	34.20		



► For DIN332 Form A+B Center Hole >>

IC	Code	Parts No.	Coating	Grade	d1	d2	d3	L1	L2	L3	CT ±0.025	
08	032011	I9MT08T1B0100-NC5074	Helica	P40	1.00	+ 0.14 0	2.12	3.15	1.3	2.21	2.51	7.55
	032012	I9MT08T1B0125-NC5074			1.25		2.65	4.0	1.6	2.75	3.14	7.90
	032013	I9MT08T1B0160-NC5074			1.60		3.35	5.0	2.0	3.46	3.93	8.40
	032014	I9MT08T1B0200-NC5074			2.00		4.25	6.3	2.5	4.39	4.98	9.10
12	033001	I9MT12T2B0200-NC2033	TiAlN	K20F	2.00	+ 0.14 0	4.25	6.3	2.5	4.39	4.98	11.73
	033002	I9MT12T2B0250-NC2033			2.50		5.3	8.0	3.1	5.53	6.28	13.0
	033003	I9MT12T2B0315-NC2033			3.15		6.7	10.0	3.9	6.90	7.85	14.0
16	034001	I9MT1603B0400-NC2033			4.00	+ 0.18 0	8.5	12.5	5.0	8.9	10.03	19.4
	034002	I9MT1603B0500-NC2033			5.00		10.6	16.0	6.3	11.15	12.68	19.4
20	035001	I9MT2004B0630-NC2033			6.30	+ 0.22 0	13.2	18.0	8.0	13.98	15.33	28.4
	035002	I9MT2004B0800-NC2033	8.00	17.0	20		10.1	17.89	18.73	28.3		
25	036001	I9MT2506B1000-NC2033	10.00	21.2	25		12.8	22.5	23.57	34.2		

1

i-Center

DIN332 Form A

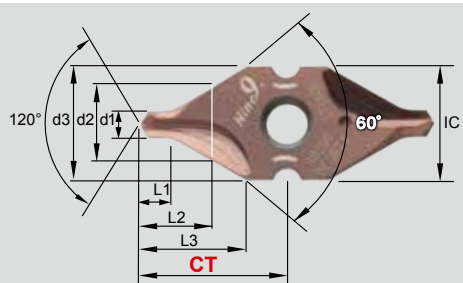

ANSI 60°

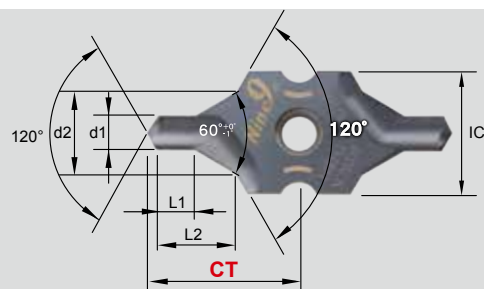

► For DIN332 Form A Center Hole >>

IC	Code	Parts No.	Coating	Grade	d1	d2	d3	L1	L2	L3	CT ±0.025
08	032114	I9MT08T1A0200-NC5074	Helica	P40	2.0	4.25	8	2.15	4.10	7.35	10.5
	032115	I9MT08T1A0250-NC5074			2.5			2.58	5.00	7.34	
	032116	I9MT08T1A0315-NC5074			3.15	6.7	3.23	6.30	7.43		



► For ANSI 60° Center Hole >>

IC	Code	Parts No.	Coating	Grade	Size	d1		d2		L1		L2		CT ±0.025
						mm		mm		mm		mm		
12	033101	I9MT12T2A2-NC2033	TiAlN	K20F	#2 5/64	1.98	+0.14 0	3/16	4.76	5/64	1.98	4.4	12.6	
	033102	I9MT12T2A3-NC2033			#3 7/64	2.78		1/4	6.35	7/64	2.78	5.9	13.8	
	033103	I9MT12T2A4-NC2033			#4 1/8	3.18	5/16	7.94	1/8	3.18	7.3	14.25		
16	034101	I9MT1603A5-NC2033			#5 3/16	4.76	+0.18 0	7/16	11.11	3/16	4.76	10.3	20.0	
	035101	I9MT2004A6-NC2033			#6 7/32	5.56		1/2	12.7	7/32	5.56	11.8	27.75	
	20	035102			I9MT2004A7-NC2033	#7 1/4	6.35	+0.22 0	5/8	15.88	1/4	6.35	14.6	28.5
035103		I9MT2004A8-NC2033			#8 5/16	7.94	3/4		19.05	5/16	7.94	17.6	29.0	
25		036101			I9MT2506A10-NC2033	#10 3/8	9.53	0.98"	25.0	3/8	9.53	22.9	34.9	

New

► Measuring Master >>

- Apply on lathe to align the center of work spindle and tool.
- Each insert has just one measuring tip.
- Concentricity: ±0.01mm

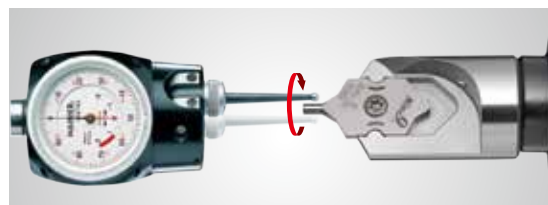

IC08

I9MT08T1-MM

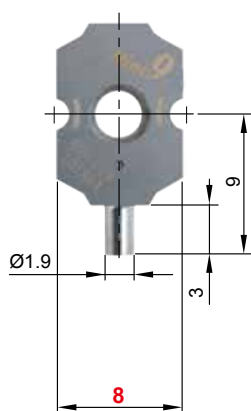

IC12

I9MT12T2-MM

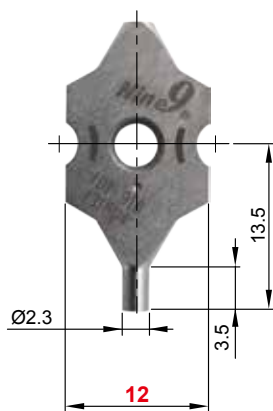

IC16

I9MT1603-MM

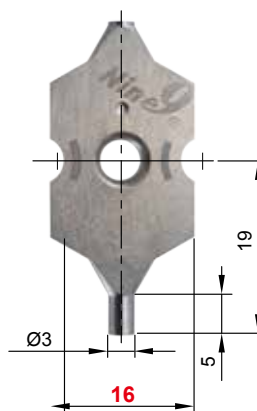

IC20

I9MT2004-MM

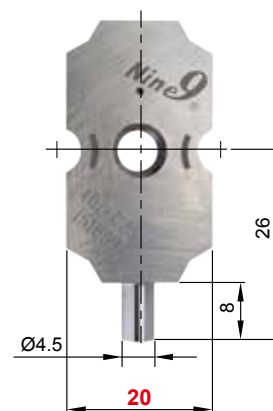

Corner Rounding

NC Spot Drill

Chamfer Mill

NC Deburring

Engraving

i-Center

Holders of Indexable Center Drill



▶ Weldon Shank >>

- Made of hardened high alloy steel, 58 HRC.
- IC08 shank is cylindrical shank. Other shanks are weldon shank.

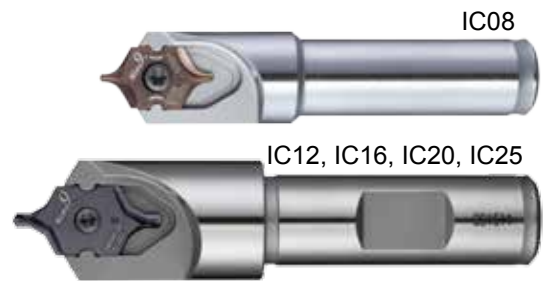
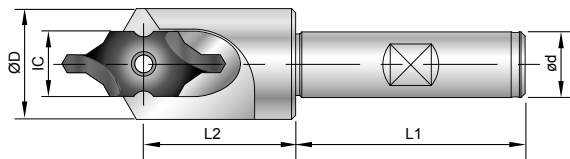

IC	Code	Parts No.	Type	Ød	L1	L2	ØD	Screw	Key
08	802002	00-99616-IC08-10F	BC10-IC08F	10	30	18.5	12	*NS-25060 0.9 Nm	NK-T7
	812002	00-99616-IC08-3/8F	BC3/8"-IC08F	3/8"					
12	803002	00-99616-IC12-16F	SB16-IC12F	16	48	30.5	21	NS-30072 2.0 Nm	NK-T9
	813002	00-99616-IC12-5/8F	SB5/8"-IC12F	5/8"					
16	804002	00-99616-IC16-16F	SB16-IC16F	16	48	37	27	NS-35080 2.5 Nm	NK-T15
	814002	00-99616-IC16-5/8F	SB5/8"-IC16F	5/8"					
20	805002	00-99616-IC20-20F	SB20-IC20F	20	50	51	32	NS-50125 5.5 Nm	NK-T20
	815002	00-99616-IC20-3/4F	SB3/4"-IC20F	3/4"					
25	806002	00-99616-IC25-25F	SB25-IC25F	25	56	56	43	NS-50125 5.5 Nm	NK-T20
	816002	00-99616-IC25-1F	SB 1"-IC25F	1"					

*Torque screwdriver is recommended, see page 6-4.

▶ Cylindrical Shank with Pre-balanced >>

- Made of hardened high alloy steel, 58 HRC.
- G6.3 / 10,000 r.p.m.

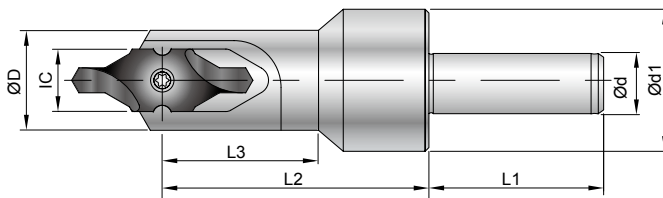

IC	Code	Parts No.	Type	Ød	Ød1	L1	L2	L3	ØD	Screw	Key
08	802003	00-99616-IC08-10B	BC10-IC08B	10	22	30	33.5	19	12	*NS-25060 0.9 Nm	NK-T7
12	803003	00-99616-IC12-12B	BC12-IC12B	12	34	48	51	30	21	NS-30072 2.0 Nm	NK-T9
16	804003	00-99616-IC16-16B	BC16-IC16B	16	39	48	67	37	27	NS-35080 2.5 Nm	NK-T15
20	805003	00-99616-IC20-20B	BC20-IC20B	20	49	50	86	51	32	NS-50125 5.5 Nm	NK-T20
25	806003	00-99616-IC25-25B	BC25-IC25B	25	59	56	99	56	43	NS-50125 5.5 Nm	NK-T20

*Torque screwdriver is recommended, see page 6-4.

1

i-Center



► Square Shank 25 x 25 Right / Left Hand >>

- For used on lathe.
- Made of hardened alloy steel, 40 HRC.
- Other sizes are available on request.

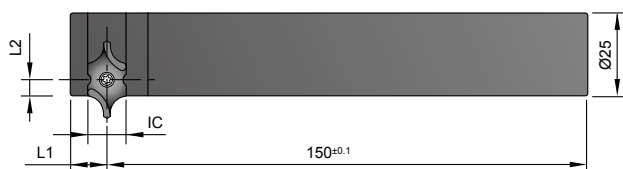

IC	Code	Parts No.	L1	L2	Screw	Key
08	822022	00-99616-IC08-R2525MF	8	3.25	*NS-25060 0.9 Nm	NK-T7
	822012	00-99616-IC08-L2525MF				
12	823022	00-99616-IC12-R2525MF	11	4.9	NS-30072 2.0 Nm	NK-T9
	823012	00-99616-IC12-L2525MF				
16	824022	00-99616-IC16-R2525MF	13	4.9	NS-35080 2.5 Nm	NK-T15
	824012	00-99616-IC16-L2525MF				

*Torque screwdriver is recommended, see page 6-4.

► Double Flat Shank >> Non-Stock Item

- Made of hardened high alloy steel, 58 HRC.
- Double flat shank type for used on lathe.
- 180° for insert at top, 90° for insert at front.

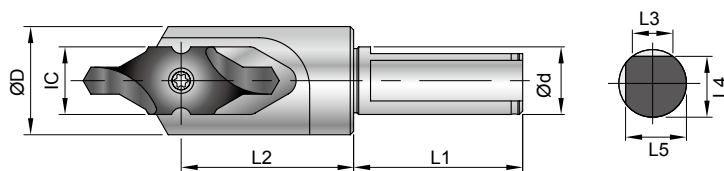

IC	Code	Parts No.	Type	Ød	L1	L2	L3	L4	L5	ØD	Screw	Key
08	802004	00-99616-IC08-10S	SL10-IC08S	10	30	18.5	6	9	9	12	*NS-25060 0.9 Nm	NK-T7
12	803004	00-99616-IC12-16S	SL16-IC12S	16	48	30.5	9.33	14.5	14.5	21	NS-30072 2.0 Nm	NK-T9
16	804004	00-99616-IC16-16S	SL16-IC16S	16	48	37	9.33	14.5	14.5	27	NS-35080 2.5 Nm	NK-T15
20	805004	00-99616-IC20-20S	SL20-IC20S	20	50	51	12	18	18	32	NS-50125 5.5 Nm	NK-T20
25	806004	00-99616-IC25-25S	SL25-IC25S	25	56	56	13.57	23	23	43	NS-50125 5.5 Nm	NK-T20

*Torque screwdriver is recommended, see page 6-4.

Center Height Adjusting Sleeve

▶ Principle >>

- Designed for adjusting Center Height of center drills, NC spot drills, reamers and taps on the CNC lathes.
- The main body is made from two sleeves. The inner sleeve is to hold and lock the cutting tool.
- Its center is inclined to the outer sleeve. When the inner sleeve is pushed or pulled, the cutting tool's center height is adjusted to lower or higher position.

▶ Parts No.:00-99600-320H >>

▶ Type : SB32-IDER20

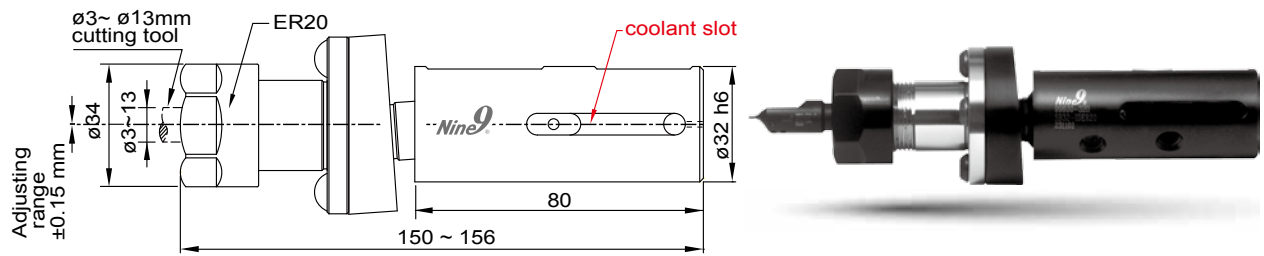

▶ Parts No.:00-99600-400H >>

▶ Type : SB32-ID16

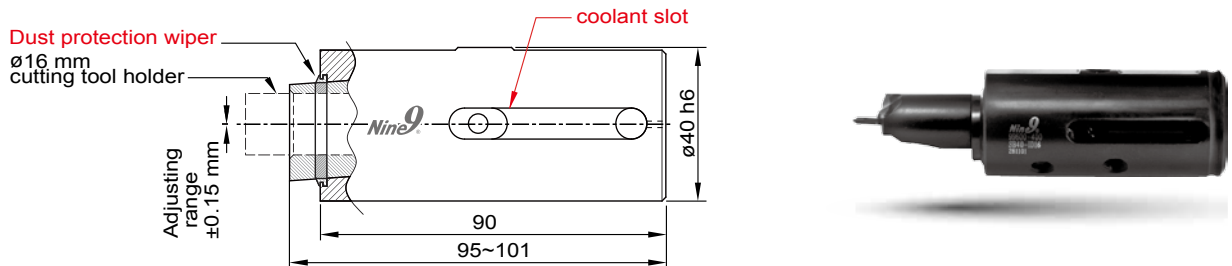

▶ Applications >>

- Used when the CNC lathes need to adjust the center height.
- This sleeve can be clamped by VDI 40, VDI 50 E2 tool holders, and other types internal turning tool holders.
- Center height adjusting range: ± 0.15 mm (.006").
- Total axial movement is 6mm (.236").

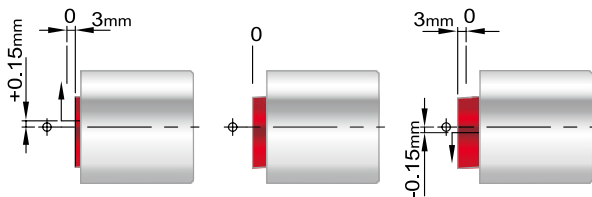

Tightening screw 4mm Hex key

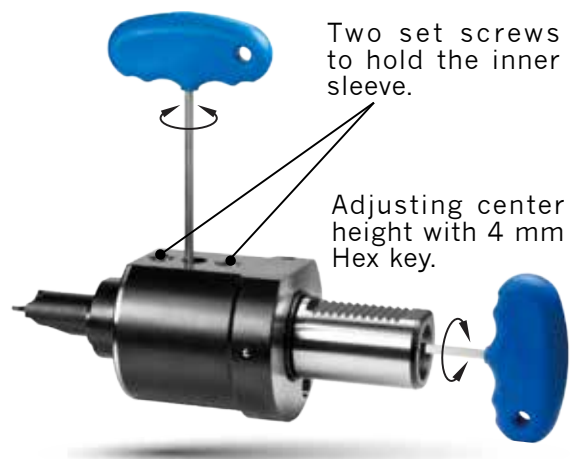

Technical Standard ISO 2541-1972 / DIN332

► 60° Center holes

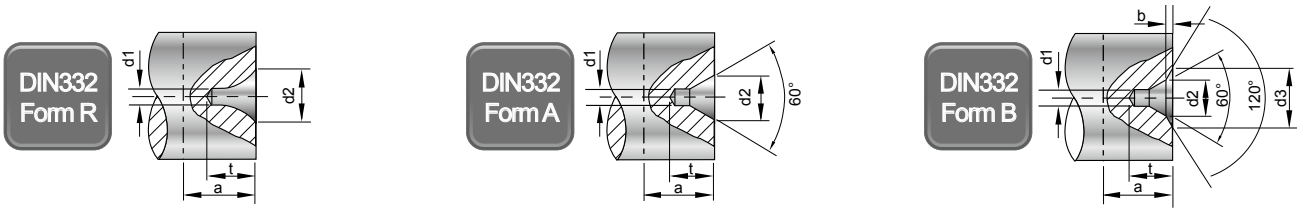

STD	DIN332 Form R ISO 2541-1972			DIN332 Form A ISO 866-1975			DIN332 Form B ISO 2540 1973					
	d1	d2	t	a	d2	t	a	d2	b	d3	t	a
1		2.12	1.9	3	2.12	1.9	3	2.12	0.3	3.15	2.2	3.5
1.25		2.65	2.3	4	2.65	2.3	4	2.65	0.4	4	2.7	4.5
1.6		3.35	2.9	5	3.35	2.9	5	3.35	0.5	5	3.4	5.5
2		4.25	3.7	6	4.25	3.7	6	4.25	0.6	6.3	4.3	6.6
2.5		5.3	4.6	7	5.3	4.6	7	5.3	0.8	8	5.4	8.3
3.15		6.7	5.8	9	6.7	5.9	9	6.7	0.9	10	6.8	10
4		8.5	7.4	11	8.5	7.4	11	8.5	1.2	12.5	8.6	12.7
5		10.6	9.2	14	10.6	9.2	14	10.6	1.6	16	10.8	15.6
6.3		13.2	11.4	18	13.2	11.5	18	13.2	1.4	18	12.9	20
8		17	14.7	22	17	14.8	22	17	1.6	22.4	16.4	25
10		21.2	18.3	28	21.2	18.4	28	21.2	2	28	20.4	31



► Advantage of Form R Center hole

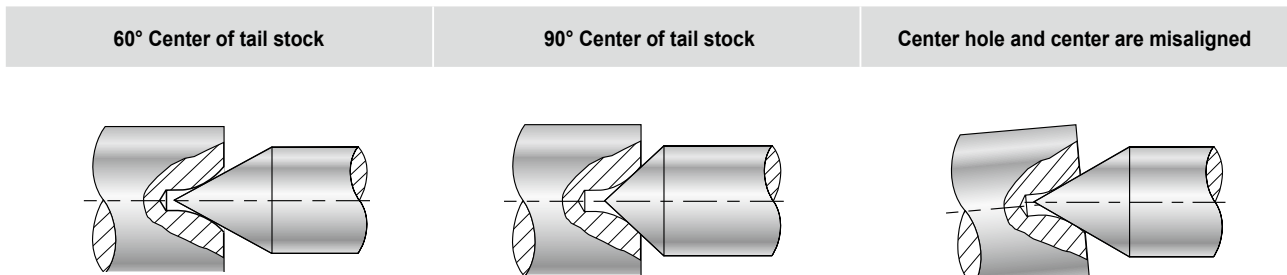

► Advantage of Form B center hole

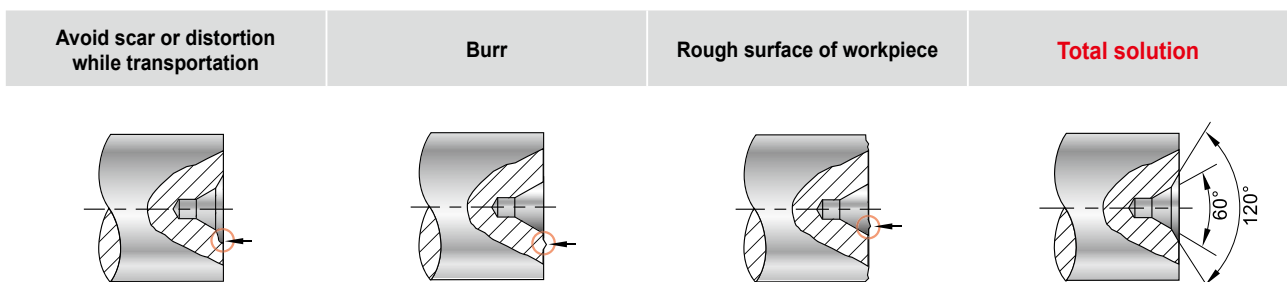

Technical Guide

Before you start, please pay attention the following conditions

! 1

Center misalignment

E must be $< 0.02\text{mm}$.

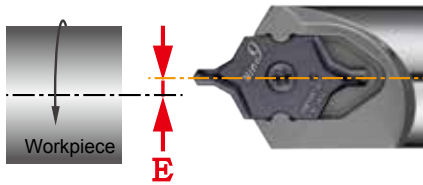

! 2

Center height adjusting sleeve

When CNC lathe turret center is misaligned $\geq 0.15\text{mm}$, please use center height adjusting sleeve. (See page 1-35)



! 3

Internal coolant

Internal coolant is recommended.



! 4

No reset and regrind

Tool length maintain while changing the insert or cutting edge.

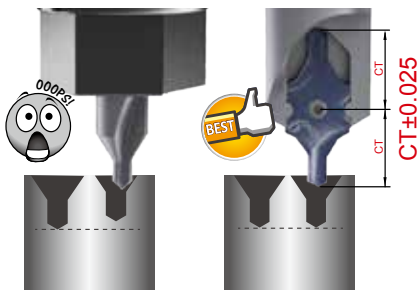

! 5

Clamping insert

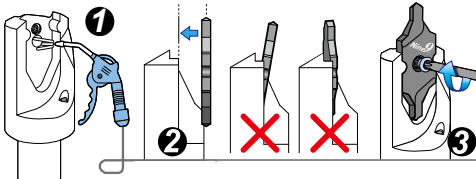

Loosen insert

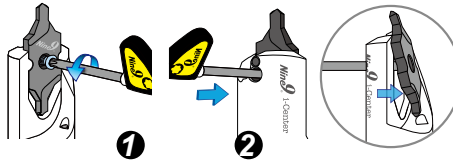

! 6

Possible to run on low r.p.m machine

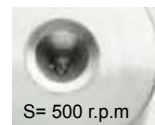

S= 500 r.p.m

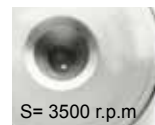

S= 3500 r.p.m

Applications

Various centering applications and products - shafts of engine, transmission gear boxes, bearings, motors, grinding parts, spindles, gear reducers, cooling fan, universal joints...

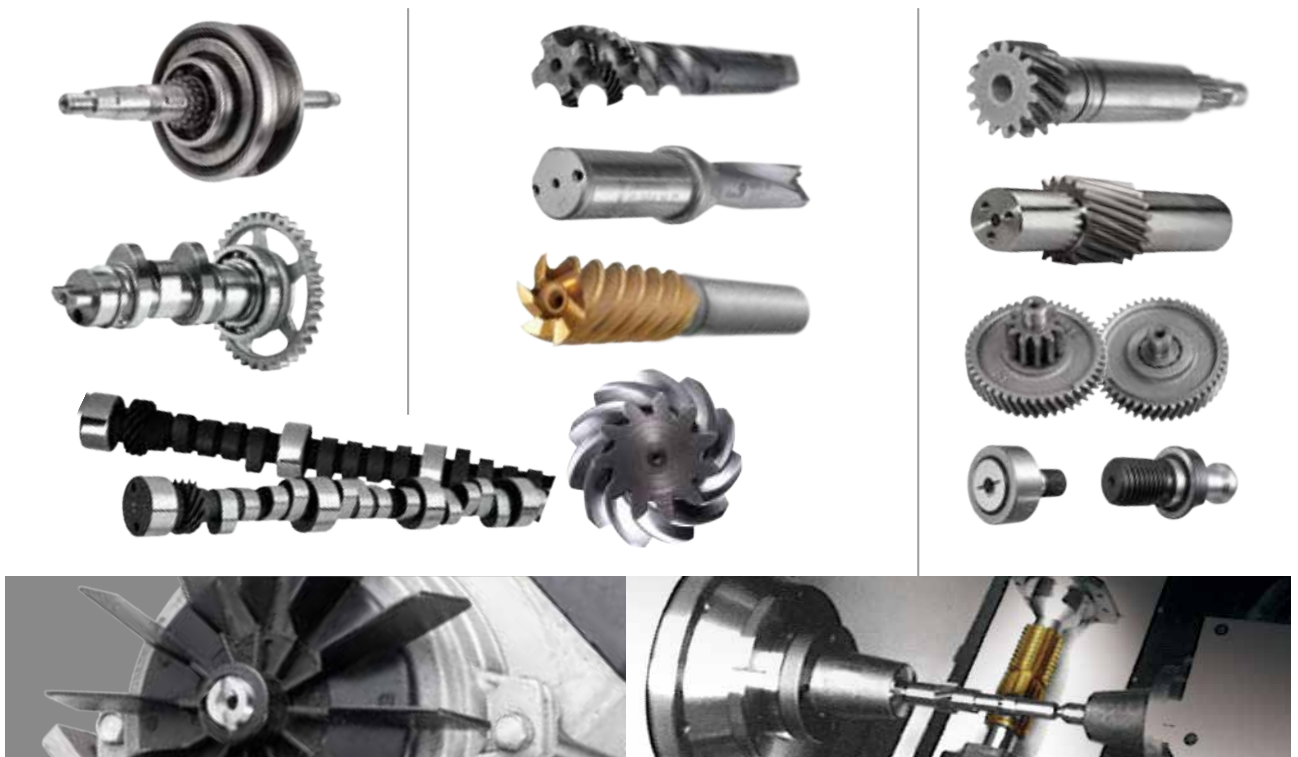

1

i-Center

Cutting Data

▶ Ø1~Ø3.15 (#2~#4)

Workpiece material	Vc (m/min.)	d1	IC08		IC12				
			Ø1~1.25	Ø1.6~3.15	Ø2 (#2)	Ø2.5 (#3)	Ø3.15 (#4)		
Carbon steel C<0.3%	< 80	S r.p.m.	2000 ~ 10000	1600 ~ 8000	1600 ~ 8000	1400 ~ 7000	1200 ~ 6000	●	○
		f mm/rev.	0.02~0.03~0.05	0.03~0.05~0.06	0.04~0.06~0.08	0.06~0.08~0.10	0.08~0.10~0.12		
Carbon steel C>0.3%	< 70	S r.p.m.	2000 ~ 9000	1600 ~ 7200	1600 ~ 7200	1400 ~ 6300	1200 ~ 5400	●	○
		f mm/rev.	0.02~0.03~0.05	0.03~0.04~0.05	0.03~0.04~0.05	0.06~0.08~0.10	0.08~0.10~0.12		
Low alloy steel C<0.3%	< 65	S r.p.m.	2000 ~ 8000	1600 ~ 6400	1600 ~ 6400	1400 ~ 5600	1200 ~ 4800	●	○
		f mm/rev.	0.01~0.02~0.04	0.02~0.03~0.05	0.02~0.03~0.05	0.04~0.06~0.08	0.06~0.08~0.10		
High alloy steel C>0.3%	< 60	S r.p.m.	1000 ~ 6000	800 ~ 4800	800 ~ 4800	700 ~ 4200	600 ~ 3600	●	○
		f mm/rev.	0.01 ~ 0.02	0.01~0.02~0.04	0.01~0.02~0.04	0.02~0.04~0.06	0.04~0.06~0.08		
Stainless steel	< 20	S r.p.m.	1000 ~ 3000	800 ~ 2400	800 ~ 2400	700 ~ 2100	600 ~ 1800	●	○
		f mm/rev.	0.003 ~ 0.01	0.005 ~ 0.02	0.01 ~ 0.02	0.01~0.02~0.03	0.02~0.03~0.05		
Casting iron	< 70	S r.p.m.	2000 ~ 9000	1600 ~ 7200	1600 ~ 7200	1400 ~ 6300	1200 ~ 5400	Air	
		f mm/rev.	0.01~0.02~0.04	0.02~0.04~0.06	0.02~0.04~0.06	0.04~0.06~0.08	0.06~0.08~0.10		
Al, and non-ferrous metal	< 200	S r.p.m.	6000 ~ 20000	4800 ~ 16000	4800 ~ 16000	4200 ~ 14000	3600 ~ 12000	●	○
		f mm/rev.	0.01~0.02~0.03	0.01~0.02~0.04	0.01~0.02~0.04	0.02~0.03~0.05	0.02~0.04~0.06		

● Best ○ Possible

▶ Ø4~Ø10 (#5~#10)

Workpiece material	Vc m/min.	d1	IC16		IC20			IC25		
			Ø4 (#5)	Ø5	(#6)	Ø6.3 (#7)	Ø8 (#8)	Ø10 (#10)		
Carbon steel C<0.3%	< 80	S r.p.m.	1000 ~ 5000	900 ~ 4500		800 ~ 4000	700 ~ 3500	600 ~ 3000	●	○
		f mm/rev.	0.08~0.12~0.14	0.10~0.12~0.16		0.10~0.14~0.16	0.12~0.15~0.18	0.14~0.18~0.20		
Carbon steel C>0.3%	< 70	S r.p.m.	1000 ~ 4500	900 ~ 4050		800 ~ 3600	700 ~ 3150	600 ~ 2700	●	○
		f mm/rev.	0.08~0.12~0.14	0.10~0.12~0.16		0.10~0.14~0.16	0.12~0.15~0.18	0.14~0.18~0.20		
Low alloy steel C<0.3%	< 65	S r.p.m.	1000 ~ 4000	900 ~ 3600		800 ~ 3200	700 ~ 2800	600 ~ 2400	●	○
		f mm/rev.	0.06~0.08~0.10	0.08~0.10~0.12		0.08~0.12~0.14	0.10~0.14~0.16	0.12~0.16~0.20		
High alloy steel C>0.3%	< 60	S r.p.m.	500 ~ 3000	450 ~ 2700		400 ~ 2400	350 ~ 2100	300 ~ 1800	●	○
		f mm/rev.	0.04~0.06~0.08	0.06~0.08~0.10		0.08~0.10~0.12	0.10~0.14~0.16	0.10~0.14~0.16		
Stainless Steel	< 25	S r.p.m.	500 ~ 1500	450 ~ 1350		400 ~ 1200	350 ~ 1050	300 ~ 900	●	○
		f mm/rev.	0.02~0.04~0.06	0.02~0.04~0.06		0.04~0.06~0.08	0.04~0.06~0.08	0.05~0.07~0.10		
Casting iron	< 70	S r.p.m.	1000 ~ 4500	900 ~ 4050		800 ~ 3600	700 ~ 3150	600 ~ 2700	Air	
		f mm/rev.	0.06~0.08~0.10	0.08~0.10~0.12		0.08~0.12~0.14	0.10~0.14~0.16	0.12~0.16~0.18		
Al, and non-ferrous metal	< 200	S r.p.m.	3000 ~ 10000	2700 ~ 9000		2400 ~ 8000	2100 ~ 7000	1800 ~ 6000	●	○
		f mm/rev.	0.02~0.04~0.06	0.04~0.06~0.08		0.04~0.06~0.08	0.06~0.08~0.10	0.06~0.08~0.10		

● Best ○ Possible

▶ Using your “d1” value and cutting speed Vc from the data sheet, calculate spindle speed “S”(r.p.m).

▶ “F” feed rate per minute F = S x f = IPR x r.p.m

Metric		Inch	
$S = \frac{Vc \times 1000}{\pi \times d1}$	d1 = diameter -mm	$S = \frac{(3.82 \times SFM)}{d1}$	d1 = diameter-inch
	S = Spindle Speed -r.p.m.		S = Spindle Speed-r.p.m.
F = S x f	Vc = Cutting Speed -m/min.	F = IPR x r.p.m	SFM = Surface Speed-ft./min. Vc (m/min.) x 3.28
	f = mm/rev.		f = IPR = inch/rev.
	F = mm/min.		F = inch/min.





Engraving 30° / 45° / 60° / 90°

This is a revolutionary new concept of engraving tools with *indexable carbide inserts*. They offer you the ability to produce HIGH QUALITY ENGRAVING in most materials. The latest coated carbide grades help you to obtain higher speed and feed rate, dramatically reducing your cycle time.

1

Features

Engraving Tool

► High Positive Rake Angle

- Indexable insert.
- Suitable for engraving all types of materials, such as plastic, non-ferrous metal, aluminum, copper, carbon steel and stainless steel.

► Multi-Side Grinding

- Full peripherally ground insert to ensure efficient repeatability.
- It performs excellently without producing any burrs, especially in copper, aluminum and stainless steel.

► High Speed, High Feed Rate

- Designed to run at high speed, up to 40,000 r.p.m.
- Feed rate 0.08mm (0.003") / rev. apply to aluminum; 0.05mm (0.002") / rev. apply to stainless steel.
- Reduces engraving cycle time!

► Economical

- Each indexable insert has 2 cutting edges.
- No resharpener required. Tool length is unchanged.
- No need to reset after changing insert or cutting edge.
- Excellent repeatability!

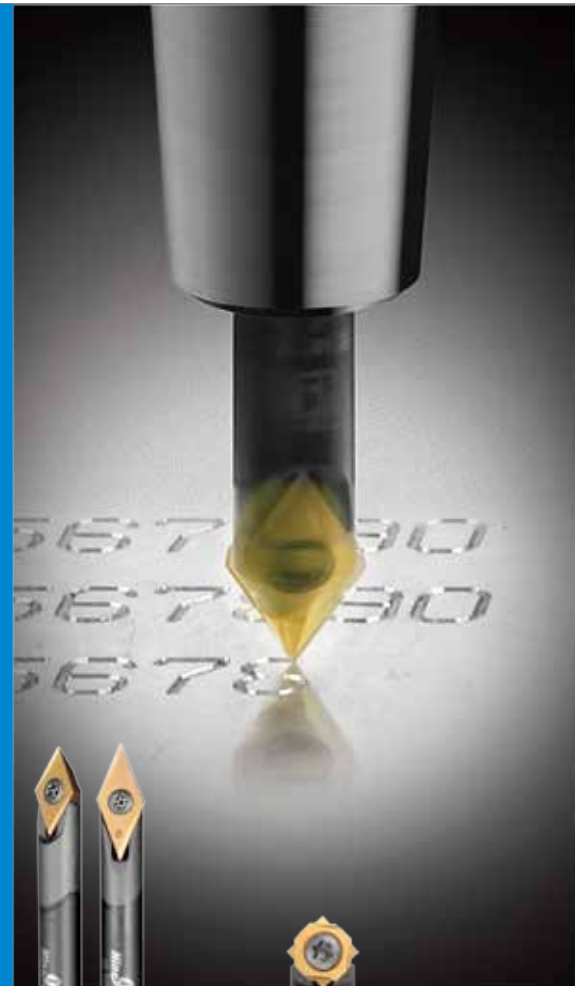

Serial number

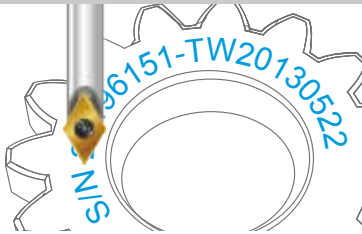

Logo outlines



Mold & Die

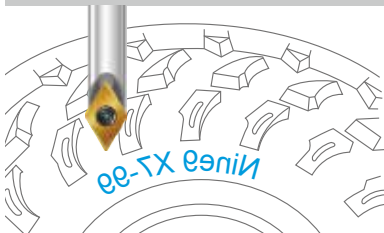

Product info

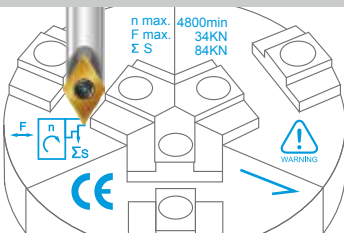

Dial scales

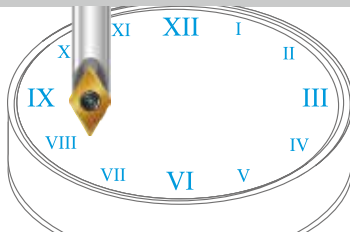

► Applications

- Serial numbers, product codes, dial scales, signs, logo, graph and almost any character which can be created by the NC programming system.



Engraving Tool

1

- ▲ Widely be used for marking on machine components, medical components, gun components, mold and die, automotive parts, gears, bearings and luxury goods.

Quick Pick

▲ Holder is also using for deburring tool. (See page 1-54)

● Holder is also using for NC Spot Drill. (See page 1-15)

1

Engraving Tool

	▲ X060 Series			V045 / V060 Series			W060 Series			● N9MT-W Series						
Features	<ul style="list-style-type: none"> Fine engraving 0.2mm bottom width with narrow angle 30° / 45° / 60°. Two type of forms- radius angled and radius. 			<ul style="list-style-type: none"> Depth of per cutting Ap up to 0.8mm for carbon steel, 0.5mm for stainless steel. See page 1-51 / 1-52. 			<ul style="list-style-type: none"> Limited design, simply for thin or light engraving, used on engraving machine 			<ul style="list-style-type: none"> Engraving inserts can be used for small diameter spotting. 						
Form																
	Radius Angled			Radius			Radius Angled			Radius Angled						
Angle	30°	45°	60°	30°	45°	60°	45°		60°		60°	90°				
Wmin.	0.2			Re: 0.2			0.45	0.65	0.25	0.45	0.65	0.1	0.2	0.3	0.2	
Wmax.	0.74	1.03	1.36	0.84	1.1	1.39	2.1		1.1	2.7		0.33	0.66	0.99	1.1	2.0
Tmax.	1.0			1.0			2.0		0.8	2.0		0.2	0.4	0.6	0.8	0.9
Edges per insert	2			2			2		2		2		4			
Work material	P M K N H			P M K N H S			P K			P K N						
Holder	99619-X060... Ø6			99619-V045... Ø6			99619-V060... Ø4 / Ø6			99619-W060-04 Ø4		99616-10 Ø10				
Ø4	-			-			30 mm			40 mm		-				
Ø6	40 / 60 mm			40 / 60 / 100 mm			40 / 60 / 100 mm			-		-				
Ø10	-			-			-			-		90 mm				
Page	1-42 ~ 1-43			1-44			1-45			1-46		1-47				

Engraving 30°/45°/60° - Radius Angled Form

X060

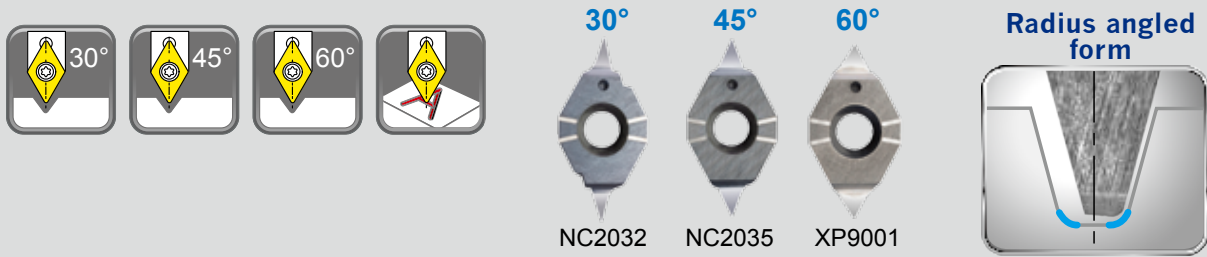

► Insert >>

NC2032: • For all kinds of steel from < 40 HRC, carbon steel, alloy steel, and cast iron.

NC2035: • ALDURA coating, reduces heat and tool wear.
• For steel with heat treatment up to 56 HRC.

XP9001: • Mirror polished, for non-ferrous metal, aluminum, brass, copper, plastic, acrylic.

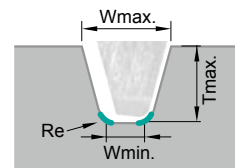

Angle	Code	Parts No.	Coating	Grade	Dimensions			Wmin.	Wmax.	Tmax.	
					L	S	Re				
30°	01X0140	NC2032	TiAlN								
	01X0141	X060A30W020R	NC2035	ALDURA	K20F	6	2.05	0.04	0.20	0.74	1.0
	01X0142	XP9001	Polished								
45°	01X0021	NC2032	TiAlN								
	01X0153	X060A45W020R	NC2035	ALDURA	K20F	6	2.05	0.04	0.20	1.03	1.0
	01X0154	XP9001	Polished								
60°	01X0063	NC2032	TiAlN								
	01X0165	X060A60W020R	NC2035	ALDURA	K20F	6	2.05	0.04	0.20	1.36	1.0
	01X0166	XP9001	Polished								

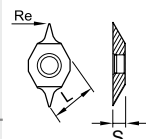

1
Engraving Tool

► Holder >>

- One holder supports the entire X060 series of engraving inserts.
- Also using for deburring tool, see page 1-54.

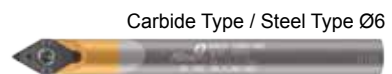
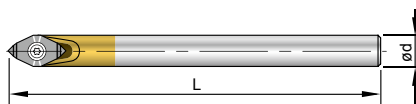

Code	Parts No.	Shank	Ød	L	Screw	Key
69X001	00-99619-X060-06	Steel	6	40		
69X002	00-99619-X060-06L	Carbide	6	60	*NS-22044 0.9Nm	NK-T7
69X003	00-99619-X060-06LS	Steel	6			

*Torque screwdriver is recommended, see page 6-4.

Engraving 30°/45°/60° - Radius Form

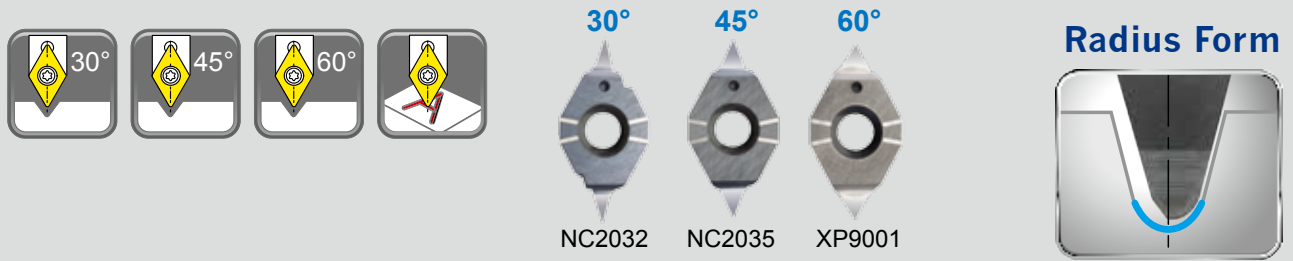

▶ Insert >>

NC2032: • For all kinds of steel from < 40 HRC, carbon steel, alloy steel, and cast iron.

NC2035: • ALDURA coating, reduces heat and tool wear.
• For steel with heat treatment up to 56 HRC.

XP9001: • Mirror polished, for non-ferrous metal, aluminum, brass, copper, plastic, acrylic.

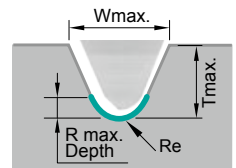

Angle	Code	Parts No.	Coating	Grade	Dimensions			R max. Depth	Wmax.	Tmax.	
					L	S	Re				
30°	01X0119	NC2032	TiAlN								
	01X0132	X060A30R020	NC2035	ALDURA	K20F	6	2.05	0.2	0.15	0.84	1.0
	01X0134	XP9001	Polished								
45°	01X0013	NC2032	TiAlN								
	01X0149	X060A45R020	NC2035	ALDURA	K20F	6	2.05	0.2	0.12	1.1	1.0
	01X0150	XP9001	Polished								
60°	01X0117	NC2032	TiAlN								
	01X0158	X060A60R020	NC2035	ALDURA	K20F	6	2.05	0.2	0.10	1.39	1.0
	01X0159	XP9001	Polished								

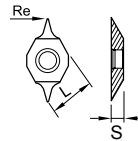

▶ Holder >>

- One holder supports the entire X060 series of engraving inserts.
- Also using for deburring tool, see page 1-54.

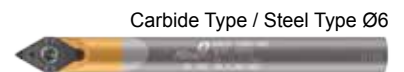
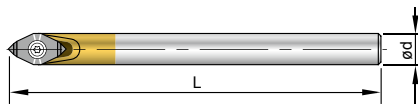

Code	Parts No.	Shank	Ød	L	Screw	Key
69X001	00-99619-X060-06	Steel	6	40		
69X002	00-99619-X060-06L	Carbide	6	60	*NS-22044 0.9Nm	NK-T7
69X003	00-99619-X060-06LS	Steel	6			

*Torque screwdriver is recommended, see page 6-4.

Engraving Tool 45°

V045

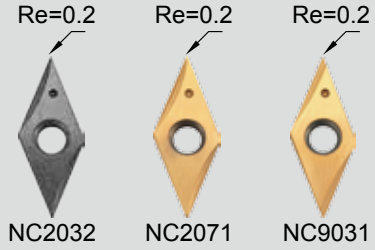

▶ Inserts >>

- NC2032:**
 - Long tool life
 - For all kinds of steel from 30~50 HRC, carbon steel, alloy steel, and cast iron.
- NC2071:**
 - Strong edge on chip groove best suited for min. DOC 0.2 mm
 - Universal grade for all kinds of steel <30 HRC, non-ferrous metal and stainless steel.
- NC9031:**
 - Fully positive ground rake angle, very sharp edge for shallow engraving.
 - For non-ferrous metal such as aluminum, brass, copper, titanium, plastic and acrylic.

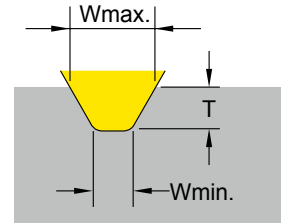

Angle	Code	Parts No.	Coating	Grade	Re	Dimensions			W		T	
						L	S	Re	Wmin.	Wmax.	Tmin.	Tmax.
45°	0104501	NC2071	TiN	K20F		6.35	2.0	0.2	0.65	2.1	0.20	2.0
	0104502	V04506T1W06	TiAlN						0.65		0.20	
	0104504	NC9031	TiN						0.45		0.05	

▶ Holder >>

- Carbide shank holders designed for shrink-fit holder, engraving machines, high speed cutting.
- XL (100mm length) is only for Al, Al-alloy cutting, unbalanced <0.6gm.



Angle	Code	Parts No.	Ød	L	Screw	Key
45°	691001	00-99619-V045-06	6	40	*NS-22044 0.9Nm	NK-T7
	♦ 691002	00-99619-V045-06L		60		
	♦ 691003	00-99619-V045-06XL		100		

Note: DC Slim chuck, see page 6-2.

*Torque screwdriver is recommended, see page 6-4.

▶ Starter Kit >> V045 & V060

Angle	Code	Parts No.	Shank Ø	Insert included	Content
45°	691201-4501	00-99619-V045-03K-71	Ø6 99619-V045-06	V04506T1W06-NC2071	1 x Holder 1 x T7 Key 3 x inserts
	691201-4502	00-99619-V045-03K-32		V04506T1W06-NC2032	
	691201-4504	00-99619-V045-03K-31		V04506T1W06-NC9031	
60°	692201-6001	00-99619-V060-03K-71	Ø6 99619-V060-06	V06006T1W06-NC2071	
	692201-6002	00-99619-V060-03K-32		V06006T1W06-NC2032	
	692201-6003	00-99619-V060-03K-35		V06006T1W06-NC2035	
	692201-6004	00-99619-V060-03K-31		V06006T1W06-NC9031	

Engraving Tool 60°

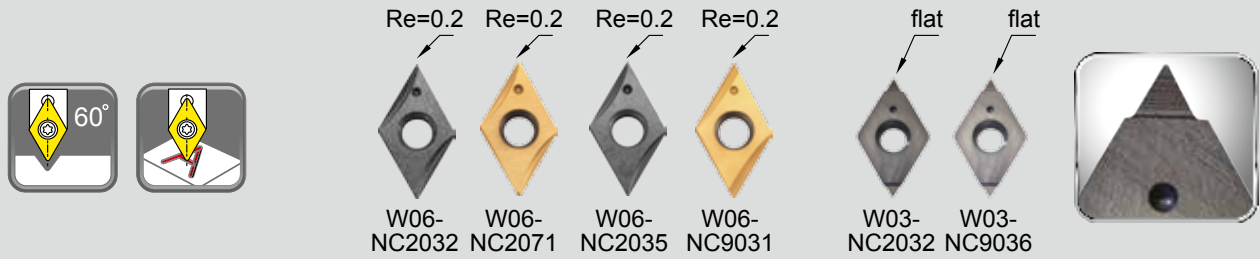

▶ Inserts >>

- NC2032:**
 - Long tool life
 - For all kinds of steel from 30~50 HRC, carbon steel, alloy steel, and cast iron.
- NC2071:**
 - Strong edge on chip groove best suited for min. DOC 0.2 mm
 - Universal grade for all kinds of steel <30HRC, non-ferrous metal and stainless steel.
- NC2035:**
 - ALDURA coating, reduces heat and tool wear.
 - For steel with heat treatment up to 56 HRC.
- NC9031:**
 - Fully positive ground rake angle very sharp edge for shallow engraving.
 - For non-ferrous metals such as aluminum, brass, copper, titanium, plastic and acrylic.
- NC9036:**
 - DLC coating, very sharp edge produces excellent surface finish.
 - For non ferrous metals such as aluminum, brass, copper, titanium, plastic and acrylic.

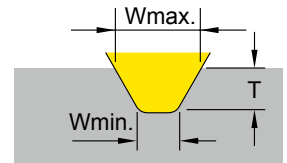

Angle	Code	Parts No.	Coating	Grade	Diagram	Dimensions			W		T	
						L	S	Re	Wmin.	Wmax.	Tmin.	Tmax.
60°	0106001	NC2071	TiN	K20F		6.35	2.0	0.2	0.65	2.7	0.20	2.0
	0106002	NC2032	TiAlN						0.65		0.20	
	0106003	NC2035	ALDURA						0.65		0.20	
	0106004	NC9031	TiN						0.45		0.05	
Angle	Code	Parts No.	Coating	Grade	Diagram	Dimensions			W		T	
60°	0106006	NC2032	TiAlN	K20F		6.35	2.0	---	0.25	1.1	0.05	0.8
	0106007	NC9036	DLC						0.25		0.05	

▶ Holder >>

- Carbide shank holders designed for shrink-fit holder, engraving machines, high speed cutting.
- XL (100mm length) is only for Al, Al-alloy cutting, unbalanced <0.6gm.

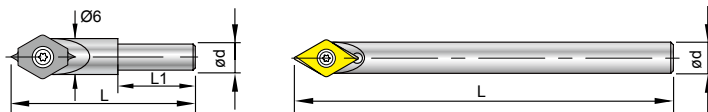

Angle	Code	Parts No.	Ød	L	L1	Screw	Key
60°	692004	00-99619-V060-04	4	30	12		NK-T7
	692001	00-99619-V060-06	6	40	---		
	♦ 692002	00-99619-V060-06L	6	60	---		
	♦ 692003	00-99619-V060-06XL	6	100	---		

Note: DC Slim chuck, see page 6-2.

*Torque screwdriver is recommended, see page 6-4.

W060 Engraving Tools

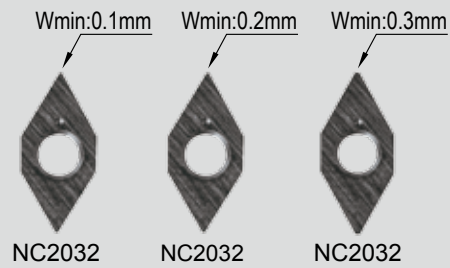
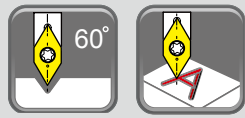

▶ Inserts >>

- Limited design, simply for thin or light engraving, used on engraving machine .
- Shank diameter 4mm is same as insert's size. Slim fits!
- Each insert has 2 cutting edges.

NC2032: • Universal grade for all unhardened steel.

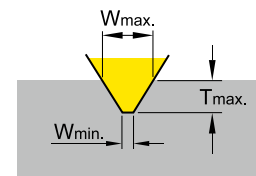

Engraving Tool

Angle	Code	Parts No.	Coating	Grade	Image	Dimensions		Wmin.	Wmax.	Tmax.
						L	S			
60°	01W2001	W06004S101-NC2032	TiAlN	K20F		4.5	1.3	0.1	0.33	0.2
	01W2002	W06004S102-NC2032				4.5	1.3	0.2	0.66	0.4
	01W2003	W06004S103-NC2032				4.5	1.3	0.3	0.99	0.6

▶ Holder >>

- Made from steel.



Angle	Code	Parts No.	Ød	L	Srew	Key
60°	69W001	00-99619-W060-04	4	40	*NS-18037 0.6Nm	NK-T6

*Torque screwdriver is recommended, see page 6-4.

Engraving 60°/90° N9MT080201W



▶ Inserts >>

- No need to reset tool length after changing insert or cutting edge.
- The inserts can be used for small diameter spotting.
- Each insert has 4 cutting edges.

60-NC40: • Very positive angle for 60° engraving for all kind of unhardened steel and cast iron.

NC40: • Universal grade for all unhardened steel.

NC10: • Universal grade for non-ferrous metal and cast iron.

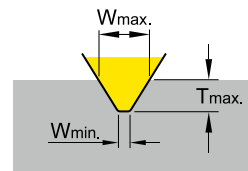

1

Engraving Tool

Angle	Code	Parts No.	Coating	Grade	Dimensions		Wmin.	Wmax.	Tmax.	
					L	S				
60°	013404	60-NC40	TiN	K20F	8	2.38	0.2	1.1	0.8	
90°	013405	N9MT080201W	NC40	TiN	K20F	8	2.38	0.2	2.0	0.9
	013406	NC10	TiAlN	K20F	8	2.38	0.2	2.0	0.9	

▶ Holder >>

- For SW engraving using **NC Spot Drill** shank.

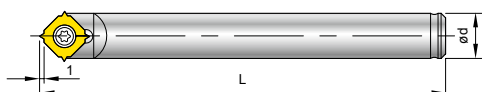

Code	Parts No.	Ød	L	Screw	Key
603001	00-99616-10	10	90	NS-30055 2.0 Nm	NK-T8
613001	00-99616-3/8	3/8"	90		

▶ Cutting Data

Engraving : Width of engraving=diameter of cutting="d"
Depth of engraving=depth of cutting="T"

- Tool shank runout should be below 0.01mm

Engraving

- For $\alpha = 90^\circ$ insert, $d=2 \times T$
- For $\alpha = 60^\circ$ insert, $d=1.73 \times T$

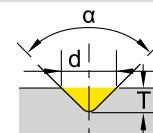

Mini spotting	Work Material	Vc (m/min)	f (mm/rev.)	Grade of Insert	Depth of cut			
					1st	2nd	3th	Finishing
	All Kind of Steel, unhardened, Cast iron	20~80	0.008~0.02	NC40	0.3	0.2	0.2	0.1
	Non-Ferrous Metal (Al, Cu)	20~100	0.008~0.02	NC10	0.3	0.2	0.2	0.1

Attention: The calculated result "d" is only for calculation of spindle speed.

Performance

► Comparison >>

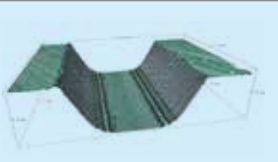
Tool				
Cutting data		00-99619-V060-06 V06006T1W06-NC2071	Engraving tool	Ball nose end mill Radius 0.4 mm
Workpiece material Tool steel SKD 61 (JIS G 4404), Hardness: HRB92~93 (HB 200)				
Spindle speed	r.p.m.	10000	10000	10000
Feed rate	mm/min.	100	100	300
Cutting depth Ap		0.2 mm	0.2 mm	0.05 mm, 4 times to cut to 0.2 mm
Roughness of bottom Ra		0.36 μm	0.83 μm	0.46 μm
Change and resetting		No need	Need	Need
Tool life		Long	Short	Short
Measured result by Alicona IFM system				

Tool		00-99619-V060-06 V06006T1W06-NC2071	00-99619-V060-06 V06006T1W06-NC2071	00-99619-V060-06 V06006T1W06-NC2035
Cutting data		SKD 51	SS	SKD 61 (50HRC)
Workpiece material		SKD 51	SS	SKD 61 (50HRC)
Spindle speed	r.p.m.	10000	10000	10000
Feed rate	mm/min.	300	300	100
Cutting depth Ap		0.1 mm	0.35 mm	0.2 mm
Change and resetting		No need	No need	No need
Tool life		24 min.(1440 sec.)	7.2 meters	3.5 meters

► Attention >>

► Selecting the speed and feed rate

- Select the spindle speed and feed rate according to the selected material's cutting data.
- The downward feed rate of the Z-axis should be reduced to **50%** of the table feed rate.

► Cutting fluid and cooling condition

- Emulsion is recommended for engraving on steel, stainless steel, Al and Al-alloy.
- Blown cooled air is recommended for engraving on cast iron and plastic.

► Setting-up the tool holder

- The tool shank runout should be below 0.01 mm.
- Shrink fit chucks, hydraulic chuck and high precision spring collet chucks are recommended.
- Pre-balance the tool holder minimum G6.3/10,000 R.P.M. is necessary.

► Clamping the engraving insert

- Place and hold the insert in the insert pocket against the positioning side.
- See illustration below:

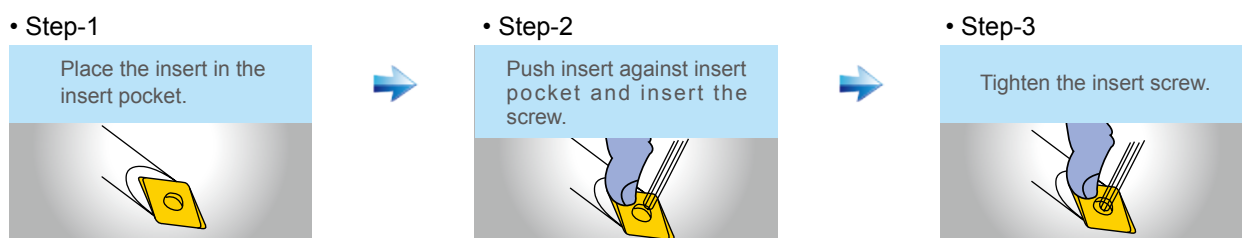

Engraving Applications

► Tip >>

Use the V045 and V060 style engravers in materials that tend to push burrs such as stainless steels and high temp alloys. These inserts have a 0.2mm(0.008") radius with a very sharp cutting edge and cut very freely. Character widths start around 0.45mm(0.017").

This tool best replaces ball nose endmills. This tool is considered to be first choice for all but fine engraving width below 0.25mm.

Components



Luxury goods



Mold & Die



Product



1

Engraving Tool

Cutting Data

⚠ Before you start, please pay attention the following conditions

- The downward feed rate of the Z-axis should be reduced to 50% of the table feed rate.
- Cutting fluid emulsion is recommended for engraving on steel, stainless steel, Al and Al-alloy; blown cooled air is recommended for engraving on cast iron and plastic.
- The tool shank runout should be below 0.01 mm.
- Shrink fit chuck, hydraulic chuck and high precision spring collet chuck are recommended.
- Pre-balance the tool holder minimum G6.3/10,000 R.P.M. is necessary.

▶ 30° Engraving X060 Insert >>

Work Material	S (r.p.m.)	f (mm/rev.)		Grade of Insert
		Radius Angled Form	Radius Form	
		X060A30W020R	X060A30R020	
Carbon steel C<0.3%	8000 ~ 40000	0.001 ~ 0.010	0.002 ~ 0.015	NC2032
Carbon steel C>0.3%		0.001 ~ 0.008	0.002 ~ 0.012	NC2032
Alloy steel		0.001 ~ 0.006	0.002 ~ 0.010	NC2032, NC2035
Stainless Steel		0.001 ~ 0.006	0.002 ~ 0.010	NC2032
Casting iron		0.001 ~ 0.006	0.002 ~ 0.010	NC2032
Aluminum		0.001 ~ 0.012	0.002 ~ 0.020	XP9001
Copper, Brass		0.001 ~ 0.012	0.002 ~ 0.020	XP9001
Hardened Steel Up to 56 HRC		0.001 ~ 0.005	0.002 ~ 0.006	NC2035

1

Engraving Tool

▶ 45° Engraving X060 Insert >>

Work Material	S (r.p.m.)	f (mm/rev.)		Grade of Insert
		Radius Angled Form	Radius Form	
		X060A45W020R	X060A45R020	
Carbon steel C<0.3%	8000 ~ 40000	0.002 ~ 0.012	0.002 ~ 0.015	NC2032
Carbon steel C>0.3%		0.002 ~ 0.010	0.002 ~ 0.012	NC2032
Alloy steel		0.002 ~ 0.010	0.002 ~ 0.010	NC2032, NC2035
Stainless Steel		0.002 ~ 0.008	0.002 ~ 0.010	NC2032
Casting iron		0.002 ~ 0.010	0.002 ~ 0.010	NC2032
Aluminum		0.002 ~ 0.015	0.002 ~ 0.020	XP9001
Copper, Brass		0.002 ~ 0.015	0.002 ~ 0.020	XP9001
Hardened Steel Up to 56 HRC		0.002 ~ 0.006	0.002 ~ 0.006	NC2035

▶ 60° Engraving X060 Insert >>

Work Material	S (r.p.m.)	f (mm/rev.)		Grade of Insert
		Radius Angled Form	Radius Form	
		X060A60W020R	X060A60R020	
Carbon steel C<0.3%	8000 ~ 40000	0.002 ~ 0.012	0.002 ~ 0.015	NC2032
Carbon steel C>0.3%		0.002 ~ 0.010	0.002 ~ 0.012	NC2032
Alloy steel		0.002 ~ 0.010	0.002 ~ 0.010	NC2032, NC2035
Stainless steel		0.002 ~ 0.008	0.002 ~ 0.010	NC2032
Casting iron		0.002 ~ 0.010	0.002 ~ 0.010	NC2032
Aluminum		0.002 ~ 0.015	0.002 ~ 0.020	XP9001
Copper, Brass		0.002 ~ 0.015	0.002 ~ 0.020	XP9001
Hardened Steel Up to 56 HRC		0.002 ~ 0.006	0.002 ~ 0.006	NC2035

Cutting Data

► Engraving Depth and Width Reference Chart

- To use the engraving chart, select your engraving width (w) on the vertical axis. Select your engraving insert angle (45° or 60°), and follow the horizontal line from the (w) axis to the intersection with the insert angle.
- Follow the vertical line from this intersection point to the engraving depth (t) axis to determine the engraving depth.

► V045/V060 T1W06 >>

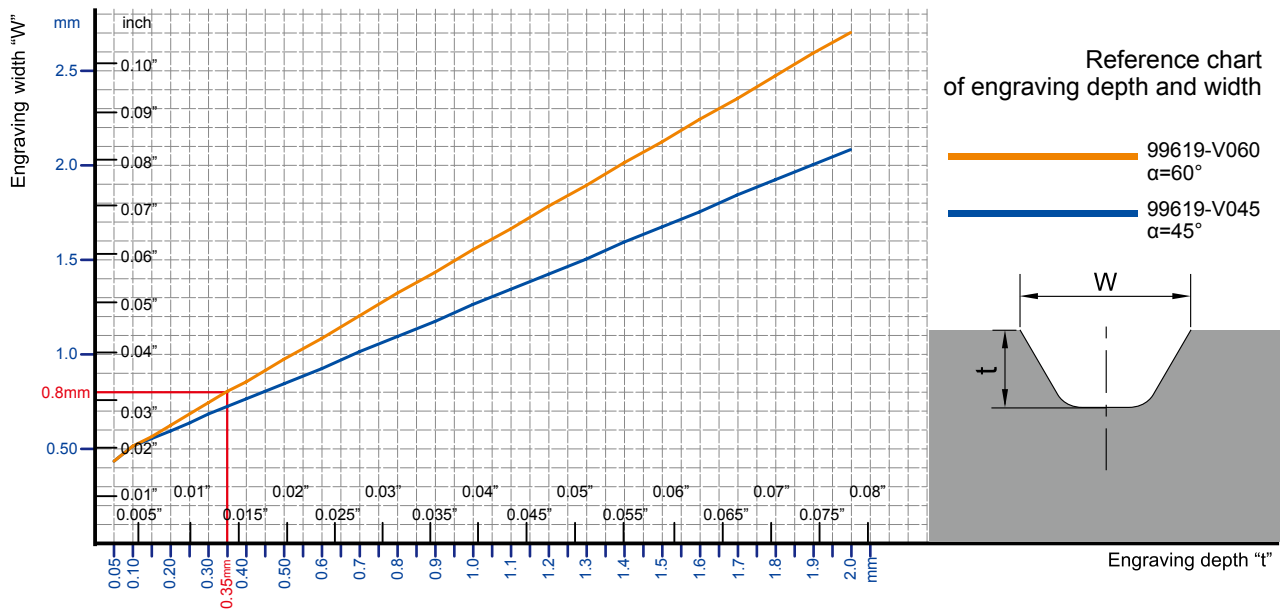

Work Material	S RPM	f (mm/rev.)	Grade of Insert
Carbon steel	5000~40000	0.008~0.05	NC2071,NC2032
Alloy steel	5000~40000	0.008~0.03	NC2032,NC2071
Stainless steel	5000~40000	0.008~0.05	NC2071,NC9031
Casting iron	5000~40000	0.008~0.03	NC2032
Aluminum \geq Non-ferrous metal	5000~40000	0.008~0.08	NC2071,NC9031
Hardened steel up to 56 HRC	6000~35000	0.003~0.01	NC2035

Tmax.:2mm

Material	Ap	Ap						~	Fine finishing
		1st	2nd	3rd	4th	5th	6th		
Carbon steel		0.8	0.6	0.3	0.2	0.1	~	~	0.1
Alloy steel		0.5	0.4	0.3	0.3	0.2	0.2	0.1	0.1
Stainless steel		0.5	0.4	0.3	0.3	0.2	0.2	0.1	0.05
Casting iron		0.8	0.6	0.3	0.2	0.1	~	~	0.1
Aluminum \geq Non-ferrous metal		1.0	0.8	0.2	~	~	~	~	0.1
Hardened steel up to 56 HRC		0.2	0.2	0.15	0.15	0.1	0.1	0.1	0.05

1

Engraving Tool

Cutting Data

▶ V060 T1W03 >>

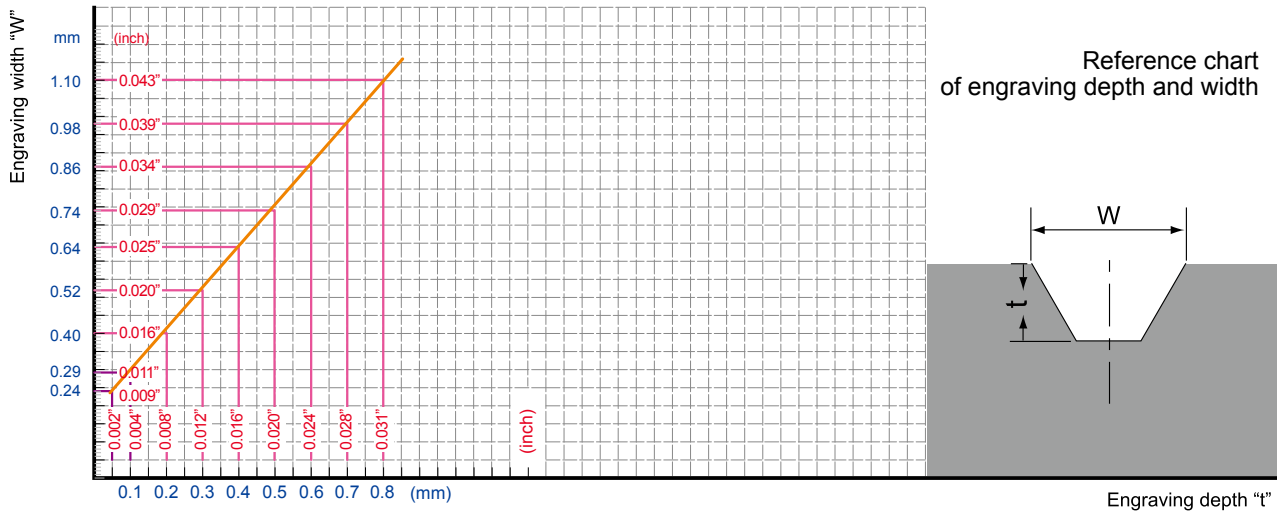

1

Engraving Tool

Work Material	S RPM	f (mm/rev.)	Grade of Insert
Carbon steel C<0.3%	8000 ~ 40000	0.005 ~ 0.010	NC2032
Carbon steel C>0.3%	8000 ~ 40000	0.005 ~ 0.015	NC2032
Alloy steel	6000 ~ 35000	0.005 ~ 0.010	NC2032
Stainless steel	8000 ~ 35000	0.003 ~ 0.010	NC9036
Casting iron	6000 ~ 35000	0.005 ~ 0.015	NC2032
Aluminum	8000 ~ 40000	0.005 ~ 0.015	NC9036
Copper, Brass	8000 ~ 40000	0.005 ~ 0.010	NC9036
Titanium	6000 ~ 15000	0.003 ~ 0.010	NC9036

Tmax.:0.8mm

Material	Ap	1st	2nd	3rd	4th	5th	~	Fine finishing
Carbon steel C<0.3%		0.3	0.2	0.1	0.1	0.05	0.05	0.03
Carbon steel C>0.3%		0.3	0.2	0.1	0.1	0.05	0.05	0.03
Alloy steel		0.3	0.1	0.1	0.05	0.05	0.05	0.03
Stainless steel		0.2	0.1	0.1	0.1	0.05	0.05	0.03
Casting iron		0.2	0.1	0.1	0.1	0.05	0.05	0.03
Aluminum		0.2	0.1	0.1	0.1	0.05	0.05	0.03
Copper, Brass		0.2	0.1	0.1	0.1	0.05	0.05	0.03
Titanium		0.2	0.1	0.1	0.1	0.05	0.05	0.03



NC Deburring

Achieve high speed and high feed deburring and chamfering on CNC machine.

Retain exceptional positional accuracy of the deburring depth and diameter.

1

Features

NC Deburring

- Indexable type, high precision ground carbide insert.
- Ideal for fine hole deburring.
- Using same tool holder of X060 engraving tool.

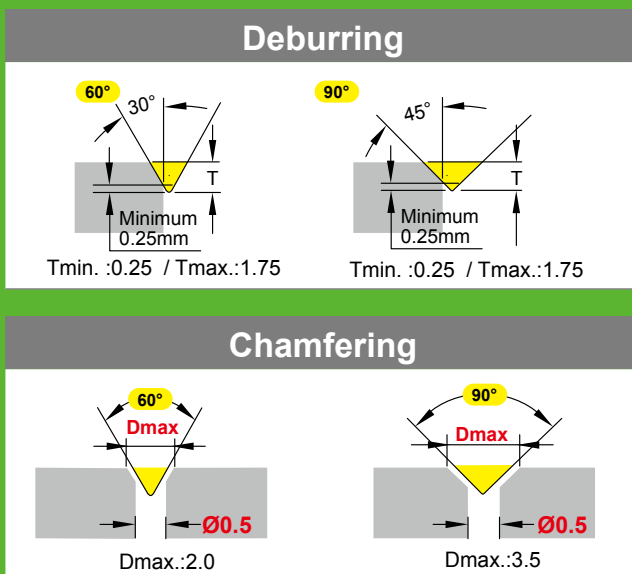

Insert has 6 flutes, capable of running 6 times higher feed rate.

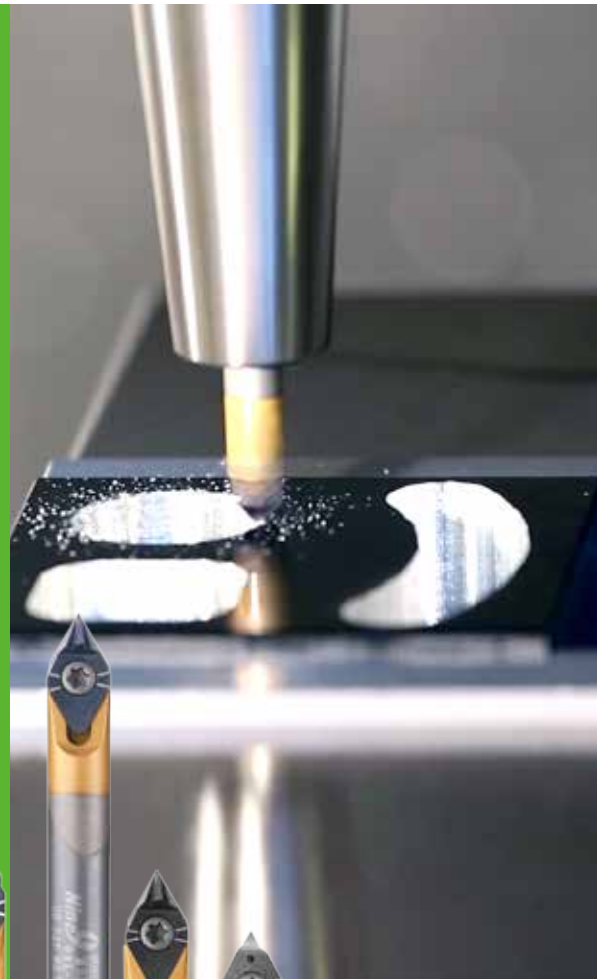

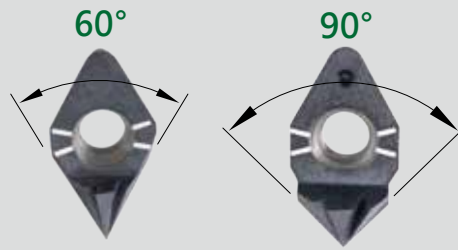

► Inserts >>

- Each insert with 6 flutes, single edge.
- TiAlN coated carbide insert can stand very long life.

NC2032: • For all kinds of steel from < 40 HRC, carbon steel, alloy steel, cast iron, aluminum and non-ferrous metal..

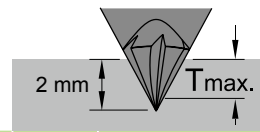

Code	Parts No.	Angle	Coating	Grade	Image	Dimensions			Tmax.	AP	
						L	S	Re		min.	max.
01X601	X060A60T6-NC2032	60°	TiAlN	K20F		6	2.0	--	1.75	0.1	1.0
01X901	X060A90T6-NC2032	90°									



► Holder >>

- Using same tool holder of X060 engraving tool.

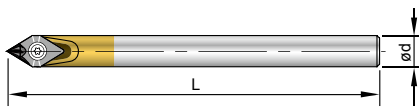

Code	Parts No.	Shank	Ød	L	Screw	Key
69X001	00-99619-X060-06	Steel	6	40	*NS-22044 0.9Nm	NK-T7
69X002	00-99619-X060-06L	Carbide		60		
69X003	00-99619-X060-06LS	Steel				

*Torque screwdriver is recommended, see page 6-4.

► Starter Kit >>

Code	Parts No.	Carbide Shank Ø	Angle	Insert included	Content
69X202-X601	00-99619-X060-DB60-02K-32	6 (99619-X060-06L)	60°	X060A60T6-NC2032	1 x Holder 1 x T7 Key 2 x inserts
69X202-X901	00-99619-X060-DB90-02K-32		90°	X060A90T6-NC2032	



► Cutting Data >>

Work Material	S (r.p.m.)	Feed Rate (mm / tooth)	Grade of Insert
Carbon Steel C<0.3%	8000~40000	0.005-0.05	NC2032
Alloy steel	6000~35000	0.005-0.04	
Stainless Steel	6000~25000	0.005-0.03	
Casting iron	6000~35000	0.005-0.03	
Aluminum, Non-Ferrous Metal	8000~40000	0.005-0.05	



Chamfer Mill 45° >>

Nine9 chamfer mill

is designed for chamfering and countersinking with an indexable insert.

The insert is a specifically designed for use in high speed machining ; the multiple flutes provide for increased feed rate, optimizing performance and reducing cutting time.

1

Features

Chamfer Mill

Ultra high speed and feed rate is the biggest advantage of Nine9 Chamfer Mills.

It is not a traditional chamfer tool, it runs 4 times faster in cutting speed and 10 times higher in feed rate. It is the most efficient tool you ever met.

► Excellent Repeatability >>

- Smallest Indexable counter sink, diameter $\varnothing 7$ mm.
- The insert is dual-relief angle, specially edge honing and optimized coated for high cutting speed.
- Optimized the number of teeth on the holder to achieve higher feed rate.



► Applications >>

- For front and back chamfering.
- 90° counter sink and 45° chamfering.
- For counter sink, circular chamfering, contour chamfering and face milling.

► Economical >>

- Each insert has 4 cutting edges.
- Long tool life.

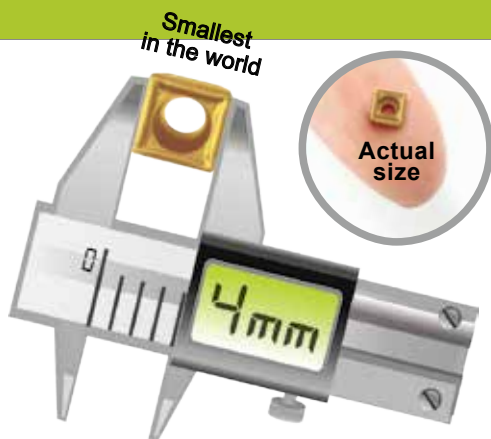

Face Milling

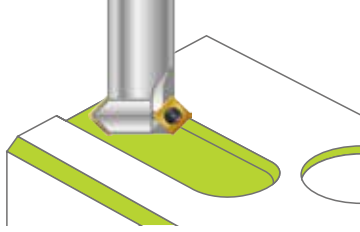

Chamfering

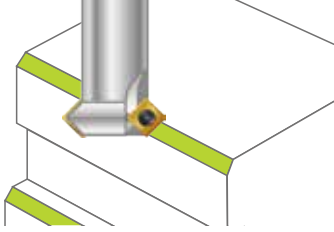

Back Chamfering

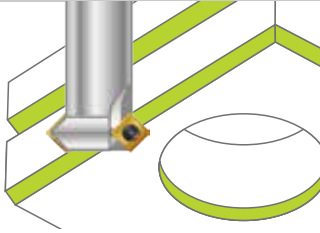

Countersink

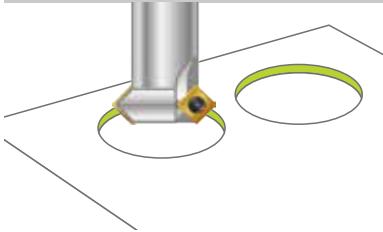

Back Circular Chamfering

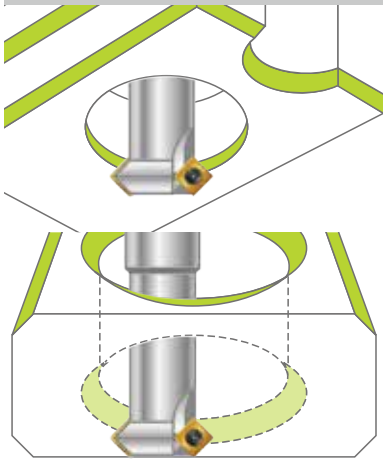

- High performance chamfer tool for upgrading your machining process.



1

Chamfer Mill

- ▲ For front and back chamfering.
Eliminates 2nd operation or deburring time.

Indexable Chamfer Mill

► Features >>

- Benefiting from the specially ground dual-relief insert and optimized coating, higher feed rates and cutting speeds can be achieved on chamfering operations.
- Each insert has 4 cutting edges, reducing insert cost.
- Fine edge honning cutting edge, good chip breaking condition and long tool life.

► Inserts >>

- NC2032:**
- AlTiN coating, very long tool life.
 - For carbon steel, alloy steel, cast iron and hardened steel up to 56HRC
 - Each insert has 4 cutting edges.
- NC9071:**
- TiN coating, very sharp cutting edge produces excellent surface finish
 - For non ferrous metal, aluminum, aluminum-alloy, brass, copper and stainless steel.
 - Each insert has 4 cutting edges.

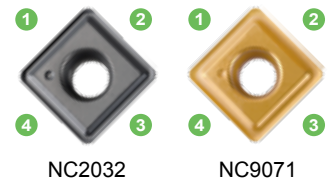

1

Chamfer Mill

Code	Parts No.	Coating	Grade		Dimensions			Screw	Key
					L	S	Re		
021401	N9GX04T002	NC2032	K20F		4.0	1.8	0.2	*NS-18037 0.6Nm	NK-T6
021402		NC9071							
023401	N9GX060204	NC2032			6.35	2.38	0.4	*NS-22055 0.9Nm	NK-T7
023402		NC9071							
025401	N9GX090308	NC2032			9.52	3.18	0.8	NS-30072 2.0Nm	NK-T9
025402		NC9071							

*Torque screwdriver is recommended, see page 6-4.

► Holder_ 99616-C02, C04, C06 >>

- Made of hot working steel and hardened.
- Elliptical necked bar to optimize the tool strength.
- Shank is ground to h6 tolerance.

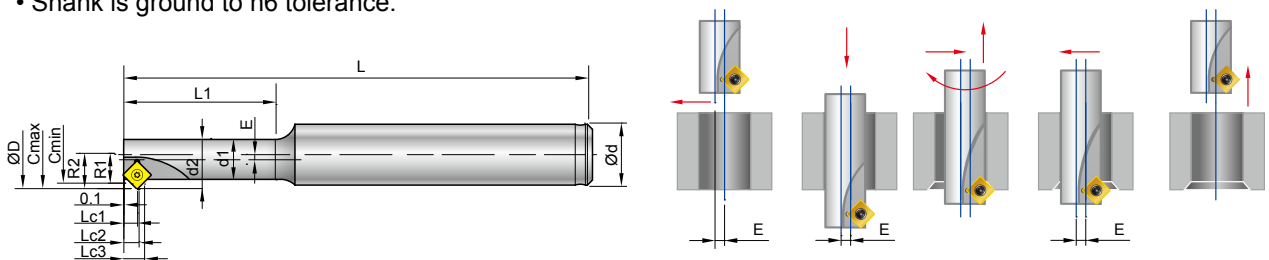

Code	Parts No.	Type	Cmin ø	Cmax ø	ød	ød1	ød2	øD	R1	R2	L	L1	Lc1	Lc2	Lc3	E	z	insert Screw / Key
701003	00-99616-C02	BC10-C02-80	6.8	8.8	10	5.25	6.5	9	3.4	4.4	80	20	2.56	2.93	3.93	1.25	1	N9GX04T002
701004	00-99616-C04	BC12-C04-100	8.5	10.8	12	6.45	8	11.1	4.25	5.4	100	25	2.51	2.98	4.13	1.55	1	*NS-18037 0.6Nm NK-T6
701005	00-99616-C06	BC12-C06-100	10.26	13.2	12	7.88	9.75	13.5	5.13	6.6	100	30	2.51	2.98	4.45	1.88	1	

*Torque screwdriver is recommended, see page 6-4.

► Holder_ 99616-C10~99616-C52 >>

- Made from tool steel.
- Shank is ground to h6 tolerance.

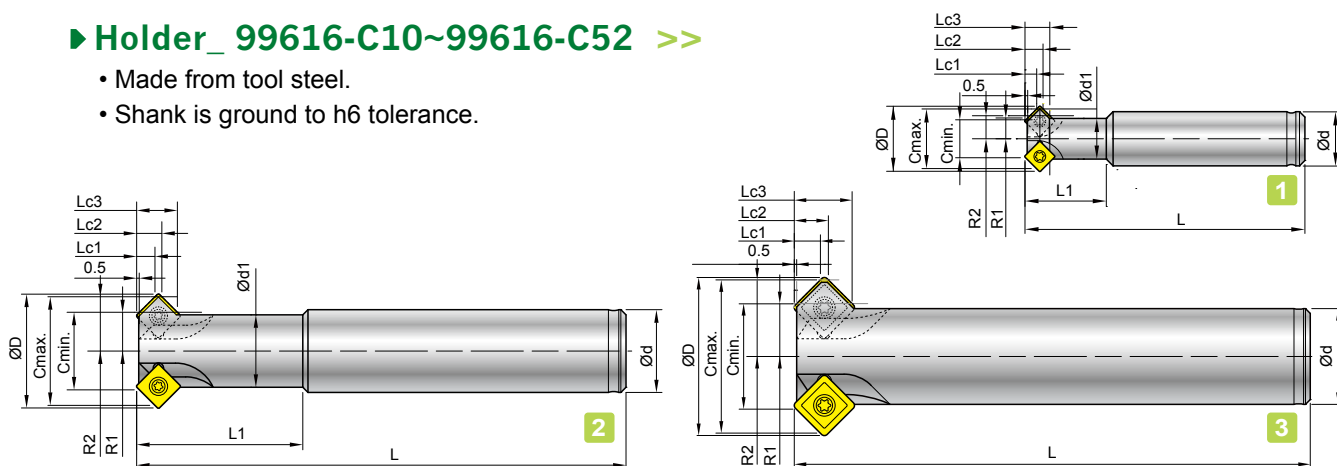

Fig	Code	Parts No.	Type	Cmin ø	Cmax ø	ød	ød1	øD	R1	R2	L	L1	Lc1	Lc2	Lc3	øz	insert Screw / Key
1	701001	00-99616-C10	BC10-C07-60	7	11	10	7.5	12	3.5	5.5	60	15	2.6	2.9	4.6	2	N9GX04T002
	701002	00-99616-C20	BC12-C11-100	11	16	12	9.6	16.15	5.5	8.0	100	25	2.6	2.9	5.0	4	*NS-18037 0.6Nm NK-T6
2	703001	00-99616-C30	BC16-C15-120	15	21	16	14	22	7.5	10.5	120	40	3.5	4.9	7.9	4	N9GX060204
	703002	00-99616-C40	BC20-C19-130	19	25	20	18	26	9.5	12.5	130	50	3.5	4.9	7.9	4	*NS-22055 0.9Nm NK-T7
3	705001	00-99616-C50	BC20-C22-130	22	32	20	--	33	11	16	130	--	5.5	7.1	12.1	4	N9GX090308
2	705002	00-99616-C52	BC25-C22-180	22	32	25	20	33	11	16	180	80	5.5	7.1	12.1	4	NS-30072 2.0Nm NK-T9

*Torque screwdriver is recommended, see page 6-4.

► Starter Kit >>

Fig	Code	Parts No.	Insert included	Holder included	Content
1	701201-1401	00-99616-C1020-32	N9GX04T002-NC2032	00-99616-C10 +	
	701201-1402	00-99616-C1020-71	N9GX04T002-NC9071	00-99616-C20	
2	703201-3401	00-99616-C3040-32	N9GX060204-NC2032	00-99616-C30 +	2 x holders
	703201-3402	00-99616-C3040-71	N9GX060204-NC9071	00-99616-C40	+ 10 inserts + 1 key
3	705201-5401	00-99616-C5052-32	N9GX090308-NC2032	00-99616-C50 +	
	705201-5402	00-99616-C5052-71	N9GX090308-NC9071	00-99616-C52	



Performance

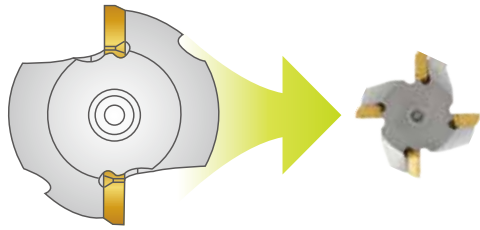



Feed Rate =
Feed per Tooth x Spindle Speed x **No. of Flute** mm/min.

UP **Spindle Speed =** $\frac{\text{Cutting Speed} \times 1000}{\pi \times C \text{min.}}$

► Test Result >> Example 1

- Chamfer tool with larger insert(Sxxx1204) and Nine9 N9GX04 insert.

Tool			
Cutting data		Nine 9 Chamfer mills	Other makers with Large insert
Chamfering		1 mm	1 mm
Feed rate	mm/rev.	0.1	0.1
Dia. of cutter	mm	11	32
Teeth of cutter		4	2
Cutting Speed Vc	m/min.	300	200
Spindle Speed	r.p.m.	8685	1990
Feed rate	mm/min	3474	398

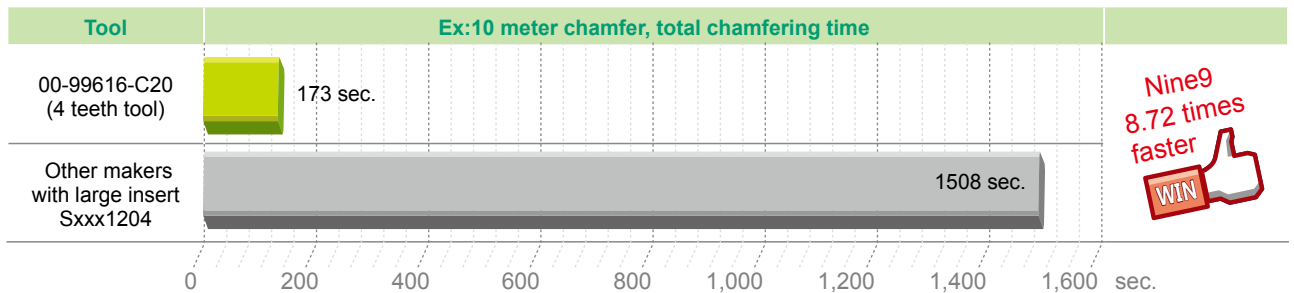
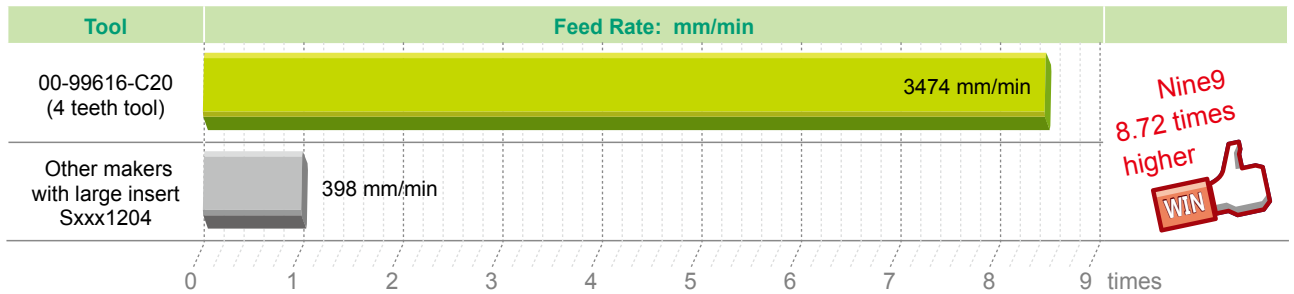

1

Chamfer Mill

Cutting Data

▶ 99616-C02, C04, C06 Cutting Data >>

Workpiece Material		Grade of insert	Cutting Speed VC m/min.	Feed Rate mm / tooth	
Material Group	Sample Code (JIS)			N9GX04T002	
				Max. Chamfering 1.5mm	
Carbon steel C<0.3%	SS400	NC2032	60-80-120	0.02 ~ 0.07	
Carbon steel C>0.3%	S50C, P5	NC2032	60-80-120	0.02 ~ 0.07	
Low alloy steel C<0.3%	SCM420	NC2032	60-80-120	0.01 ~ 0.04	
High alloy steel C>0.3%	SKD11	NC2032	60-80-120	0.02 ~ 0.07	
Stainless steel	SUS304	NC9071	30-60-100	0.01 ~ 0.04	
Cast iron	FC25	NC2032	60-80-120	0.02 ~ 0.06	
Al, and non-ferrous metal	A6061	NC9071	80-100-150	0.03 ~ 0.10	

1
Chamfer Mill

▶ 99616-C10~C52 Cutting Data >>

Workpiece material		Grade of insert	Cutting Speed Vc m/min.	Feed rate mm / tooth		
Material Group	Sample Code (JIS)			N9GX04T002	N9GX060204	N9GX090308
				Max. Chamfering 1.5mm	Max. Chamfering 2.5mm	Max. Chamfering 4mm
Carbon steel C<0.3%	SS400	NC2032	150-250-350	0.06~0.12	0.10~0.25	0.10~0.25
Carbon steel C>0.3%	S50C,P5	NC2032	200-300-400	0.06~0.10	0.10~0.20	0.10~0.25
Low alloy steel C<0.3%	SCM420	NC2032	180-240-260	0.06~0.10	0.10~0.20	0.10~0.20
High alloy steel C>0.3%	SKD11	NC2032	120-150-200	0.06~0.10	0.10~0.15	0.10~0.15
Stainless steel	SUS304	NC9071	120-150-180	0.06~0.10	0.06~0.15	0.10~0.20
Casting iron	FC25	NC2032	120-150-180	0.06~0.10	0.10~0.15	0.10~0.20
Al, and non-ferrous metal	A6061	NC9071	200-400-600	0.06~0.15	0.10~0.25	0.10~0.25
Hardened steel<50 HRC	SKD61	NC2032	80-90-100	0.06~0.10	0.06~0.12	0.10~0.15



NC Helix Drill

One Tool Performs Multiple Applications

2

Rough Milling,
Drilling & Slotting

NC Helix Drill

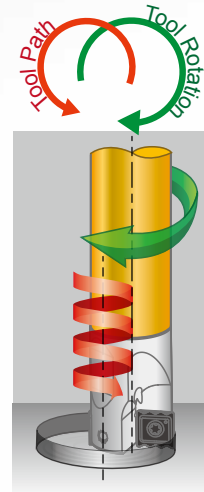

All NC Helix Drill must be programmed by helical interpolation

Reduce Your Tool Inventory

Only six tools for making $\text{Ø}13\sim\text{Ø}65\text{mm}$ hole from solid.

Each holder can machine different diameters and hole depths, saving your tool inventory and cost!

No need to peck drill or dwell in operation even machine without internal coolant.

**Low Cost!
Economy!**

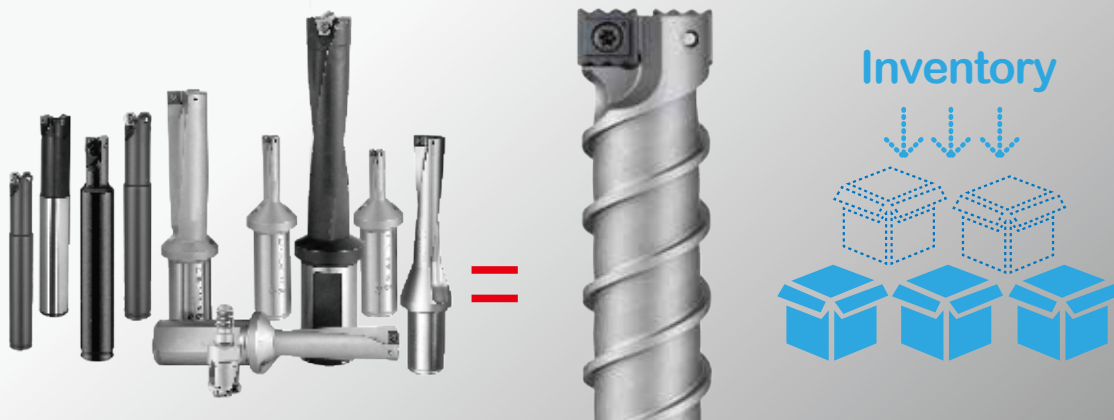



◀ **Cylindrical shank**
Apply external coolant

◀ **Patented Screw fit**
With center coolant hole

Swarf Control:
Small & Short

Extension Bar ▶
For 4xDc ~ 8xDc deep hole drilling

◀ Ti6Al4V, Titanium

2

NC Helix Drill

20° Ramping Angle
Either linear or circular ramping.

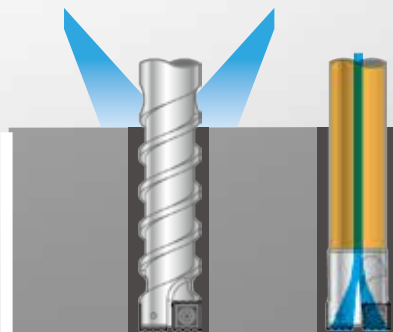

Two types of shank
Drilling depth up to 8xDc

20°

01

Feature

Lower spindle power consumption Easy to cut!

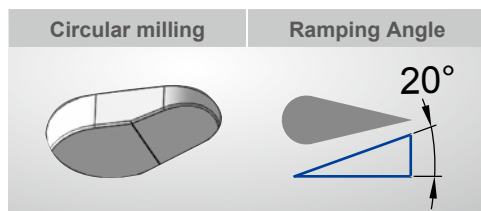

- Thanks to the small cutting load of the serrated cutting edge and helical interpolation lower power consumption. Work quicker, smarter and achieve better results.
- Circular ramping milling, maximum ramping angle is 20°.
For example: tool HD27 machining $\varnothing 50$ mm hole, 9 mm pitch for aluminum, 6 mm pitch for carbon steel.

2

NC Helix Drill

02

Feature

Just six tools for drilling $\varnothing 13 \sim \varnothing 65$ mm or larger

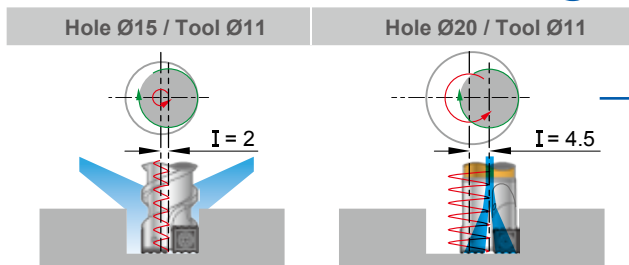

- Cuts by helical interpolation.
- Each holder can machine different diameters and hole depths.
- Enlarger hole is adaptable by using 99323 internal coolant cutter.

03

Feature

Special insert geometry - exceptional swarfs control.

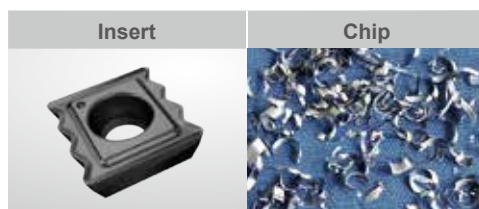

- Serrated cutting edge makes the chips short and small, and easier to evacuate.
- Eliminate swarf and vibration problems while drilling difficult material or deeper holes.
- Excellent swarfs control for providing safe and rational chip removal for modern automation.



"One tool" performs multiple applications

04
Feature



- Not only a drill, but an end mill too.
- Small radius path to cut a hole or step hole, various curved cavity shapes on different materials, reduce tool number and cutting time.

Functions in variable conditions It's so easy!

05
Feature

2

NC Helix Drill

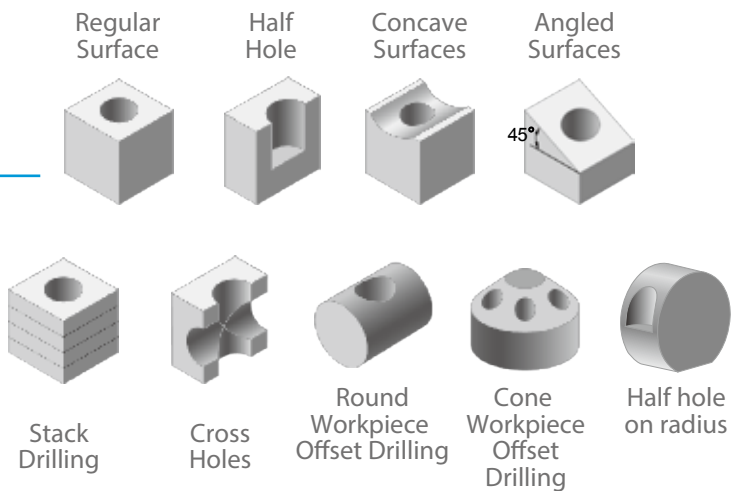

Strength
Opportunities
Extraordinary
ures

Roughness Measuring

Feature 06

- Making a flatness at bottom just by NC program, easy and smart!

Workpiece

Make "One more turn" after reached the depth.
Ex:
:
G03 I-1.5 Z-30 P5
G03 I-1.5 <make one more turn >
G01 X0 Y0 < afterward, let tool back to center of hole >

Flatness

```

Perthometer P1
Object
Name
#
Lt 0.520 mm
La Standard 0.50 mm
Lc 0.500 mm
Rz 1.270 mm
Rq 0.61 mm
Rmax 7.71 mm
RPa10.5 - 0.21 40 %
R Profile
Lr 0.482 mm
VPr 0.52 mm
    
```

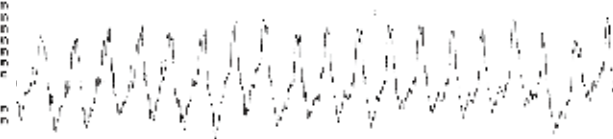

Inserts

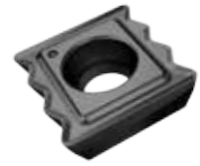

NC5072 : P40, TiAlN coating.

General purpose, suitable for almost all kind of steel, stainless steel and Titanium.
Recommended while clamping devices is unstable or deep hole drilling or apply on low power machines .

NC2032 : K20F, TiAlN coating.

Design for high performance cutting, special good for cast iron and hardened material <HRC50°.

● Best ◎ Suit ○ Possible

		P Steel	M SS	K Cast Iron	N Aluminum	S Titanium	H Hardened
NC5072		●	●	◎	◎	◎	○
NC2032		◎	○	●	◎	○	◎

Code	Parts No.	Grade	Coating	Dimensions			Screw	Key	
				L	S	Re			
041021 041001	01-N9MX04T002	NC5072 NC2032	P40 K20F	TiAlN	4.75	1.8	0.2	NS-18037 0.6Nm	NK-T6
042021 042001	01-N9MX05T103	NC5072 NC2032	P40 K20F	TiAlN	5.75	2.0	0.3	NS-20045 0.6Nm	NK-T6
043021 043001	01-N9MX070204	NC5072 NC2032	P40 K20F	TiAlN	7.5	2.4	0.4	NS-25045 0.9Nm	NK-T7
044021 044001	01-N9MX100306	NC5072 NC2032	P40 K20F	TiAlN	10.0	3.18	0.6	NS-30072 2.0Nm	NK-T9
045021 045001	01-N9MX12T308	NC5072 NC2032	P40 K20F	TiAlN	12.5	3.97	0.8	NS-35080 2.5Nm	NK-T15

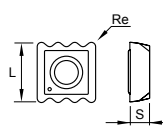

*Torque screwdriver is recommended, see page 6-4.

2

NC Helix Drill

Holder

Cylindrical Shank (made from hardened high alloy steel)

► Helical chip-removing groove >>

- Designed for CNC machines with external coolant.
- Unique helical groove design generates chip removing coolant stream.
- The helical groove is designed for the coolant to remove swarf from the cutting zone.

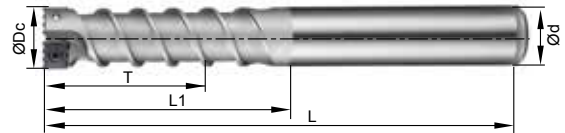

Code	Parts No.	Type	Capable of drill dia. mm		ØDc	T	L1	L	Ød	Insert type	Max. ramping angle
			Dmin.	Dmax.							
401001	00-99321-010-1320	BC10-HD11-1320	13	20	11	30	40	80	10	N9MX04T002	20°
402001	00-99321-012-1525	BC12-HD13-1525	15	25	13	36	50	100	12	N9MX05T103	20°
403001	00-99321-016-2030	BC16-HD17-2030	20	30	17	50	60	110	16	N9MX070204	20°
404001	00-99321-020-2540	BC20-HD22-2540	25	40	22	60	70	125	20	N9MX100306	20°
405001	00-99321-025-3050	BC25-HD27-3050	30	50	27	75	85	165	25	N9MX12T308	20°

Side Lock Shank

► With Internal Coolant

- Special size is available on request.

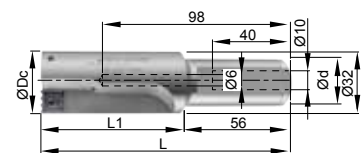

Code	Parts No.	Type	Capable of drill dia. mm		ØDc	L	L1	Ød	Max. Depth	Insert type	Max. ramping angle
			Dmin.	Dmax.							
405002	00-99321-025-4265	SL25-HD33-4265	42	65	33	130	74	25	50	N9MX12T308	9°

Screw Fit Cutter

► With Internal Coolant

- Designed for CNC machines with internal coolant.
- Standard screw-fit body adapts to almost any kind of the screw-fit tool holder or extension bar in the market.
- Possible apply for enlarge hole.

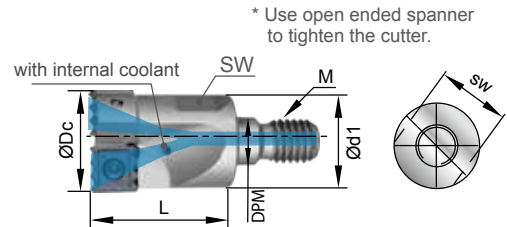

Code	Part No.	Type	Capable of drill dia. mm		ØDc	L	M	DPM	Ød1	SW	Insert type	Max. ramping angle
			Dmin.	Dmax.								
421001	00-99323-010-1320	M05-HD11-1320	13	20	11	20	M5	5.5	10	8	N9MX04T002	20°
422001	00-99323-012-1525	M06-HD13-1525	15	25	13	25	M6	6.5	12	10	N9MX05T103	20°
423001	00-99323-016-2030	M08-HD17-2030	20	30	17	25	M8	8.5	16	14	N9MX070204	20°
424001	00-99323-020-2540	M10-HD22-2540	25	40	22	30	M10	10.5	20	18	N9MX100306	20°
425001	00-99323-025-3050	M12-HD27-3050	30	50	27	35	M12	12.5	25	23	N9MX12T308	20°

Extension Bar

Steel Type

- T is the maximum overhang length.
- With internal coolant hole.

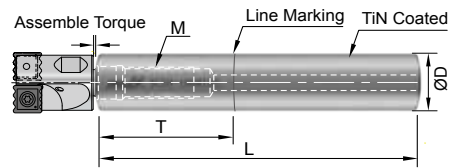

Code	Parts No.	Type	ØD	T	L	M	Assembled Torque
970100	00-99801-10S	BC10-075M05S	10	25	75	M5xP0.8	6.5 Nm
970122	00-99801-12S	BC12-075M06S	12	25	75	M6xP1.0	11.0 Nm
970161	00-99801-16S	BC16-090M08S	16	35	90	M8xP1.25	25.0 Nm
970202	00-99801-20S	BC20-100M10S	20	40	100	M10xP1.5	50.0 Nm
970253	00-99801-25S	BC25-120M12S	25	50	120	M12xP1.75	60.0 Nm

Solid Carbide Type (REVA)

- T is the maximum overhang length.
- With internal coolant hole.
- Carbide extension bar with longer tool length is available on request.

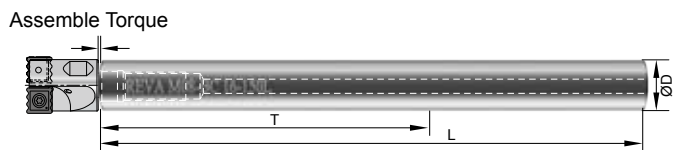





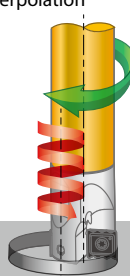

Parts No.	Type	ØD	T	L	M	Assembled Torque
0-398010-100M05	M05-BC10-100L	10	60	100	M5xP0.8	6.5 Nm
0-398012-100M06	M06-BC12-100L	12	60	100	M6xP1.0	11.0 Nm
0-398016-150M08	M08-BC16-150L	16	80	150	M8xP1.25	25.0 Nm
0-398020-200M10	M10-BC20-200L	20	100	200	M10xP1.5	50.0 Nm
0-398025-200M12	M12-BC25-200L	25	125	200	M12xP1.75	60.0 Nm

** Nine9 TiN coated extension bar is also available please refer to page 6-3.

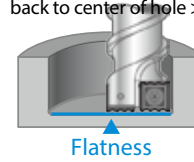
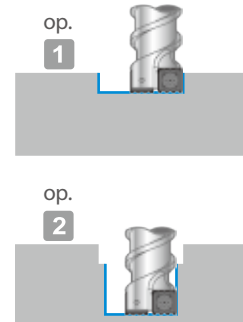
Technical Guide

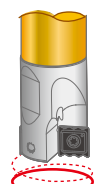
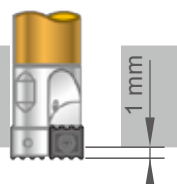
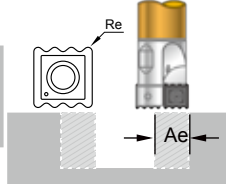
※ Before you start, please pay attention the following conditions >>

1	2	3	4	5														
<p>Programming</p> <p>All NC Helix Drills must be programmed using helical interpolation</p> 	<p>Recommend of Direction</p> <p>Tool path of moving downward by CCW (G03), Tool Rotation by CW direction is recommended.</p> 	<p>Flatness on blind hole bottom</p> <p>Make <u>one more turn</u> after reaching depth. Ex.: G03 I-1.5 Z-30 P5 G03 I-1.5 <make one more turn > G01 X0 Y0 < afterward return tool back to center of hole ></p> 	<p>Step Hole</p> <p>From solid is more safe and reduce the cutting time.</p> 	<p>External coolant</p> <p>Lower pressure higher volume is recommended. Minimum 5 bar. Aim nozzle toward the tool body, let the coolant effectively enter the hole.</p> 														
6	7	8	9	10														
<p>For Start</p> <table border="1"> <tr> <td>Vc</td> <td>fz</td> <td>Pitch</td> </tr> <tr> <td colspan="3" style="text-align: center; font-size: small;">By Spindle Power</td> </tr> </table> <p>Result adjusting</p> <table border="1"> <tr> <td>Upgrade</td> <td>Improve</td> </tr> <tr> <td>P ↑ adj. 1</td> <td>fz ↓ adj. 1</td> </tr> <tr> <td>Vc ↑ adj. 2</td> <td>P ↓ adj. 2</td> </tr> <tr> <td>fz ↓ adj. 3</td> <td></td> </tr> </table>	Vc	fz	Pitch	By Spindle Power			Upgrade	Improve	P ↑ adj. 1	fz ↓ adj. 1	Vc ↑ adj. 2	P ↓ adj. 2	fz ↓ adj. 3		<p>Through hole</p> <p>Reduce Vc 50% at last cycle.</p> 	<p>Through hole Add 1mm to the required depth (Z)</p> <p>Failure to program beyond the through hole may result in insert breakage due to the force from circular interpolation.</p> 	<p>Enlarge Hole</p> <p>Choosing a 99323 drill body with internal coolant. Max. Ae=Dc- (Rex2) for enlarging hole.</p> 	<p>Internal coolant</p> <p>High pressure is recommended. Minimum 10 bar. Recommended for 3xDc ~8xDc Use.</p> 
Vc	fz	Pitch																
By Spindle Power																		
Upgrade	Improve																	
P ↑ adj. 1	fz ↓ adj. 1																	
Vc ↑ adj. 2	P ↓ adj. 2																	
fz ↓ adj. 3																		

2

NC Helix Drill

※ Choosing a suitable drill body.

- Required hole diameter is within the recommended range (**blue numbers**).
- Required hole diameters (more than one size), choose the drill can cover more different hole diameters.
- 3xDc~8xDc drilling, 99323 series is recommended.

Drilling diameter	Coolant type	Max. drilling depth	Tool type	Dc	Insert type	Re	Max. Ae
13- 15-20	Internal	80 mm	00-99323-010-1320	11	N9MX04T002	0.2	10.6
	External	30 mm	00-99321-010-1320	11			
15- 20-25	Internal	85 mm	00-99323-012-1525	13	N9MX05T103	0.3	12.4
	External	36 mm	00-99321-012-1525	13			
20- 25-30	Internal	105 mm	00-99323-016-2030	17	N9MX070204	0.4	16.2
	External	50 mm	00-99321-016-2030	17			
25- 30-40	Internal	130 mm	00-99323-020-2540	22	N9MX100306	0.6	20.8
	External	60 mm	00-99321-020-2540	22			
30- 40-50	Internal	160 mm	00-99323-025-3050	27	N9MX12T308	0.8	25.4
	External	75 mm	00-99321-025-3050	27			
42- 50-65	Internal	50 mm	00-99321-025-4265	33	N9MX12T308	0.8	31.4

✳ The NC Helix Drill is programmed using "Helical interpolation" on CNC machine, CNC controller must have 3-axis simultaneously motion function.

NC Helix Drill	Cutting Parameters (S & F)	Formula
	$S = \frac{Vc \times 1000}{Dc \times \pi}$ r.p.m.	Dc = Dia. of drill mm
	$F = S \times fz \times Z$ mm/min.	D = Dia. of hole mm
	$d = D - Dc$ mm	L = Depth of drilling mm
	$I = \frac{(D-Dc)}{2}$ mm	Vc = Cutting speed m/min.
	Cutting time (T)	S = Spindle speed r.p.m.
	$T = \frac{\pi \times d \times L \times 60}{F \times P}$ sec.	I = Circular radius mm
	Chip removal Volume rate (Q)	fz = Feed rate mm/tooth
	$Q = \frac{\pi \times D^2 \times L \times 60}{4 \times 1000 \times T}$ cm ³ /min.	F = Table feed rate mm/min.
		d = Circular diameter (D-Dc) mm
		P = Pitch of helical interpolation mm
	T = Cutting time sec.	
	Q = Chip removal volume rate cm ³ / min.	
	Z = Insert tooth	

Actual Feed Rate (fcut)

$$f_{cut} = fz \times 2 \times \eta \left(\sqrt[3]{1 + \frac{P}{I}} \right)$$

η = Power factor

Power Factor (η) Suggestion Table

Spindle Power	Power Factor
< 12KW	0.7-0.8
12-20 KW	0.8-0.9
> 20KW	0.9-1.0

Ramping Angle

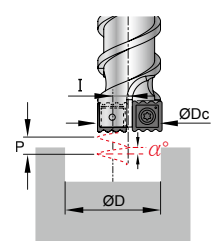

Circular ramping (α)

$$\alpha = \tan^{-1} \frac{P}{(D-Dc) \times \pi}$$
 degree

P < 2.2 x Circular radius (I)

α < 20°

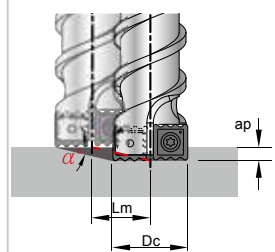

Linear ramping (α)

$$\alpha = \tan^{-1} \frac{ap}{Lm}$$
 degree

Max. ap < 3/4 of insert length

✳ Length of tool path for linear ramping.

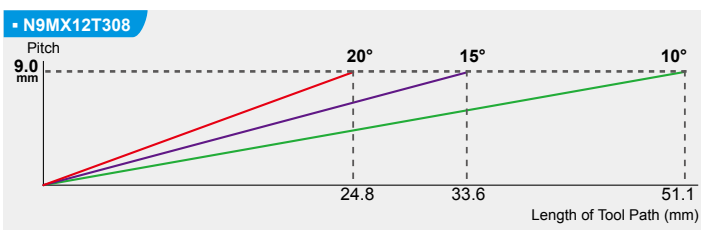
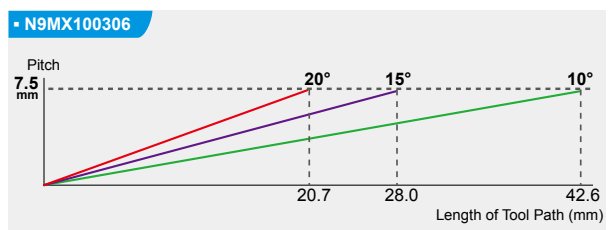
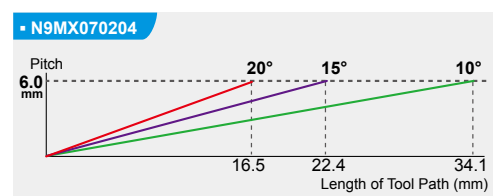
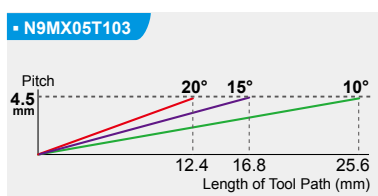
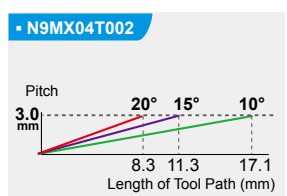

Length of tool path for Circular raming= (D-Dc) x 3.14





Cutting Data

Low machine power <12KW choose lower pitch,
high machine power >20KW choose higher pitch

► 00-99321-010-1320 / 00-99323-010-1320 >>

Workpiece material	Vc m/min.		Ø13				Ø16				Ø20			
	 99321	 99323	fz mm/tooth	Pitch mm			fz mm/tooth	Pitch mm			fz mm/tooth	Pitch mm		
P Carbon steel 0.25%C	120	200	0.025	0.60	0.80	1.00	0.055	0.90	1.20	1.50	0.08	1.20	1.60	2.00
	120	200	0.025	0.60	0.80	1.00	0.055	0.90	1.20	1.50	0.08	1.20	1.60	2.00
	100	150	0.025	0.60	0.75	0.90	0.05	0.80	1.10	1.35	0.07	1.00	1.40	1.80
	70	120	0.02	0.50	0.65	0.80	0.05	0.70	0.95	1.20	0.06	1.00	1.30	1.60
	60	90	0.02	0.50	0.65	0.80	0.05	0.70	0.95	1.20	0.06	1.00	1.30	1.60
M Stainless steel	60	90	0.02	0.50	0.65	0.80	0.05	0.70	0.95	1.20	0.06	1.00	1.30	1.60
K Cast iron	70	120	0.025	0.60	0.80	1.00	0.055	0.90	1.20	1.50	0.08	1.20	1.60	2.00
N Al	345	500	0.025	0.90	1.20	1.50	0.055	1.30	1.80	2.25	0.08	1.80	2.40	3.00
	200	400	0.025	0.70	0.95	1.20	0.055	1.00	1.40	1.80	0.08	1.40	1.90	2.40
S Ni- alloy	20	28	0.01	0.50	0.65	0.80	0.015	0.70	0.95	1.20	0.03	0.90	1.30	1.60
	40	60	0.01	0.50	0.65	0.80	0.015	0.70	0.95	1.20	0.03	0.90	1.30	1.60
H Hardened	60	90	0.02	0.50	0.65	0.80	0.05	0.70	0.95	1.20	0.06	1.00	1.30	1.60

► 00-99321-012-1525 / 00-99323-012-1525 >>

Workpiece material	Vc m/min.		Ø15				Ø20				Ø25			
	 99321	 99323	fz mm/tooth	Pitch mm			fz mm/tooth	Pitch mm			fz mm/tooth	Pitch mm		
P Carbon steel 0.25%C	120	200	0.035	1.20	1.60	2.00	0.065	1.50	2.00	2.50	0.09	1.80	2.40	3.00
	120	200	0.035	1.20	1.60	2.00	0.065	1.50	2.00	2.50	0.09	1.80	2.40	3.00
	100	150	0.03	1.10	1.50	1.80	0.06	1.30	1.78	2.25	0.08	1.60	2.15	2.70
	70	120	0.025	1.00	1.30	1.60	0.05	1.20	1.60	2.00	0.07	1.40	1.90	2.40
	60	90	0.025	1.00	1.30	1.60	0.05	1.20	1.60	2.00	0.07	1.40	1.90	2.40
M Stainless steel	60	90	0.025	1.00	1.30	1.60	0.05	1.20	1.60	2.00	0.07	1.40	1.90	2.40
K Cast iron	70	120	0.035	1.20	1.60	2.00	0.065	1.30	1.90	2.50	0.09	1.80	2.40	3.00
N Al	345	500	0.035	1.80	2.00	2.20	0.065	2.20	2.98	3.75	0.09	2.70	3.60	4.30
	200	400	0.035	1.40	1.90	2.20	0.065	1.80	2.40	3.00	0.09	2.10	2.85	3.60
S Ni- alloy	20	28	0.0125	1.00	1.30	1.60	0.0225	1.20	1.60	2.00	0.03	1.40	1.90	2.40
	40	60	0.0125	1.00	1.30	1.60	0.0225	1.20	1.60	2.00	0.03	1.40	1.90	2.40
H Hardened	60	90	0.025	1.00	1.30	1.60	0.05	1.20	1.60	2.00	0.07	1.40	1.90	2.40



2

NC Helix Drill



Cutting Data

Low machine power <12KW choose lower pitch,
high machine power >20KW choose higher pitch

▶ 00-99321-016-2030 / 00-99323-016-2030 >>

Workpiece material	Vc m/min.		Ø20			Ø25			Ø30					
	 99321	 99323	fz mm/tooth	Pitch mm			fz mm/tooth	Pitch mm			fz mm/tooth	Pitch mm		
P Carbon steel 0.25%C	120	200	0.04	1.80	2.40	3.00	0.08	2.10	2.80	3.50	0.105	2.40	3.20	4.00
	120	200	0.04	1.80	2.40	3.00	0.08	2.10	2.80	3.50	0.105	2.40	3.20	4.00
	100	150	0.035	1.60	2.15	2.70	0.07	1.90	2.55	3.20	0.09	2.10	2.85	3.60
	70	120	0.03	1.40	1.90	2.40	0.065	1.60	2.20	2.80	0.08	1.90	2.55	3.20
	60	90	0.03	1.40	1.90	2.40	0.065	1.60	2.20	2.80	0.08	1.90	2.55	3.20
M Stainless steel	60	90	0.03	1.40	1.90	2.40	0.065	1.60	2.20	2.80	0.08	1.90	2.55	3.20
K Cast iron	70	120	0.04	1.80	2.40	3.00	0.08	2.10	2.80	3.50	0.105	2.40	3.20	4.00
N Al	345	500	0.04	2.70	3.00	3.40	0.08	3.10	4.05	5.00	0.105	3.60	4.80	5.60
	200	400	0.04	2.10	2.85	3.40	0.08	2.50	3.35	4.20	0.105	2.80	3.80	4.80
S Ni-alloy	20	28	0.015	1.40	1.90	2.40	0.15	1.60	2.20	2.80	0.04	1.90	2.55	3.20
	40	60	0.015	1.40	1.90	2.40	0.04	1.60	2.20	2.80	0.04	1.90	2.55	3.20
H Hardened	60	90	0.03	1.40	1.90	2.40	0.065	1.60	2.20	2.80	0.08	1.90	2.55	3.20

▶ 00-99321-020-2540 / 00-99323-020-2540 >>

Workpiece material	Vc m/min.		Ø25			Ø32			Ø40					
	 99321	 99323	fz mm/tooth	Pitch mm			fz mm/tooth	Pitch mm			fz mm/tooth	Pitch mm		
P Carbon steel 0.25%C	120	200	0.05	1.80	2.40	3.00	0.12	2.40	3.20	4.00	0.12	3.00	4.00	5.00
	120	200	0.05	1.80	2.40	3.00	0.12	2.40	3.20	4.00	0.12	3.00	4.00	5.00
	100	150	0.04	1.60	2.15	2.70	0.08	2.20	2.90	3.60	0.11	2.70	3.60	4.50
	70	120	0.035	1.40	1.90	2.40	0.07	1.90	2.55	3.20	0.095	2.40	3.20	4.00
	60	90	0.035	1.40	1.90	2.40	0.07	1.90	2.55	3.20	0.095	2.40	3.20	4.00
M Stainless steel	80	90	0.035	1.40	1.90	2.40	0.07	1.90	2.55	3.20	0.095	2.40	3.20	4.00
K Cast iron	70	120	0.05	1.80	2.40	3.00	0.095	2.40	3.20	4.00	0.12	3.00	4.00	5.00
N Al	345	500	0.05	2.70	3.00	3.40	0.095	3.60	4.80	6.00	0.12	4.50	6.00	7.50
	200	400	0.05	2.10	2.85	3.40	0.095	2.90	3.85	4.80	0.12	3.60	4.80	6.00
S Ni-alloy	40	50	0.02	1.40	1.90	2.40	0.035	1.90	2.55	3.20	0.045	2.40	3.20	4.00
	80	90	0.02	1.40	1.90	2.40	0.035	1.90	2.55	3.20	0.045	2.40	3.20	4.00
H Hardened	80	90	0.035	1.40	1.90	2.40	0.07	1.90	2.55	3.20	0.095	2.40	3.20	4.00



2

NC Helix Drill

Cutting Data

Low machine power <12KW choose lower pitch,
high machine power >20KW choose higher pitch

▶ 00-99321-025-3050 / 00-99323-025-3050 >>

Workpiece material	Vc m/min.		Ø30				Ø40				Ø50			
	 99321	 99323	fz mm/tooth	Pitch mm			fz mm/tooth	Pitch mm			fz mm/tooth	Pitch mm		
P Carbon steel 0.25%C	120	200	0.055	2.40	3.00	3.40	0.12	3.00	4.00	5.00	0.135	3.60	4.80	6.00
	120	200	0.055	2.40	3.00	3.40	0.12	3.00	4.00	5.00	0.135	3.60	4.80	6.00
	100	150	0.05	2.20	2.90	3.40	0.10	2.70	3.60	4.50	0.12	3.20	4.30	5.40
	70	120	0.04	1.90	2.55	3.20	0.09	2.40	3.20	4.00	0.11	2.90	3.85	4.80
	60	90	0.04	1.90	2.55	3.20	0.09	2.40	3.20	4.00	0.11	2.90	3.85	4.80
M Stainless steel	60	90	0.04	1.90	2.55	3.20	0.09	2.40	3.20	4.00	0.11	2.90	3.85	4.80
K Cast iron	70	120	0.055	2.40	3.00	3.40	0.115	3.00	4.00	5.00	0.135	3.60	4.80	6.00
N Al	345	500	0.055	2.50	3.00	3.40	0.115	4.50	6.00	7.50	0.135	5.40	7.20	9.00
	200	400	0.055	2.50	3.00	3.40	0.115	3.60	4.80	6.00	0.135	4.30	5.75	7.20
S Ni-alloy	20	28	0.02	1.90	2.55	3.20	0.045	2.40	3.20	4.00	0.055	2.90	3.85	4.80
	40	60	0.02	1.90	2.55	3.20	0.045	2.40	3.20	4.00	0.055	2.90	3.85	4.80
H Hardened	60	90	0.04	1.90	2.55	3.20	0.09	2.40	3.20	4.00	0.11	2.90	3.85	4.80

▶ 00-99321-025-4265 >>

Workpiece material	Vc m/min.	Ø42				Ø55				Ø65			
	 99321	fz mm/tooth	Pitch mm			fz mm/tooth	Pitch mm			fz mm/tooth	Pitch mm		
P Carbon steel 0.25%C	200	0.08	3.00	4.00	5.00	0.12	3.30	4.40	5.50	0.135	3.60	4.80	6.00
	150	0.08	3.00	4.00	5.00	0.12	3.30	4.40	5.50	0.135	3.60	4.80	6.00
	130	0.075	2.70	3.60	4.50	0.11	3.00	4.00	5.00	0.12	3.20	4.30	5.40
	120	0.065	2.40	3.20	4.00	0.095	2.60	3.50	4.40	0.11	2.90	3.85	4.80
	90	0.065	2.40	3.20	4.00	0.095	2.60	3.50	4.40	0.11	2.90	3.85	4.80
M Stainless steel	90	0.065	2.40	3.20	4.00	0.095	2.60	3.50	4.40	0.11	2.90	3.85	4.80
K Cast iron	120	0.08	3.00	4.00	5.00	0.12	3.30	4.40	5.50	0.135	3.60	4.80	6.00
N Al	500	0.08	4.50	6.00	7.50	0.12	4.90	6.55	8.20	0.135	5.40	7.20	9.00
	200	0.08	3.60	4.80	6.00	0.12	4.00	5.30	6.60	0.135	4.30	5.75	7.20
S Ni-alloy	28	0.03	2.40	3.20	4.00	0.045	2.60	3.50	4.40	0.055	2.90	3.85	4.80
	90	0.03	2.40	3.20	4.00	0.045	2.60	3.50	4.40	0.055	2.90	3.85	4.80
H Hardened	90	0.065	2.40	3.20	4.00	0.095	2.60	3.50	4.40	0.11	2.90	3.85	4.80

2

NC Helix Drill

Application Example

► Special insert geometry is able to cut different materials >>

- Serrated cutting edge makes the chips short and small, and easier to evacuate.
- Recommended for almost all material types, good for drilling material that generates long, soft chips.

Example 1



SAE8620 SUS304 C1100 AL6061T6 TiAl6V4 Inconel 718

BT40, 22.5KW | Hole size: Ø25 x 50L mm | Tool: 00-99321-016-2030

Material: SAE8620		Load 25% P
Vc	= 120 m/min.	
S	= 2250 r.p.m.	
fz	= 0.08 mm/tooth	
F	= 360 mm/min	
P	= 5.6 mm	
T	= 40 sec.	

Material: SUS304 (Stainless steel 304)		Load 25% M
Vc	= 80 m/min.	
S	= 1500 r.p.m.	
fz	= 0.04 mm/tooth	
F	= 120 mm/min	
P	= 5.6 mm	
T	= 118 sec.	

Material: C1100		Load 25% N
Vc	= 200 m/min.	
S	= 3750 r.p.m.	
fz	= 0.08 mm/tooth	
F	= 600 mm/min	
P	= 5.6 mm	
T	= 23 sec.	

Material: AL6061T6		Load 20% N
Vc	= 345 m/min.	
S	= 6500 r.p.m.	
fz	= 0.10 mm/tooth	
F	= 1300 mm/min	
P	= 5.6 mm	
T	= 11 sec.	

Material: TiAl6V4		Load 24% S
Vc	= 80 m/min.	
S	= 1500 r.p.m.	
fz	= 0.04 mm/tooth	
F	= 120 mm/min	
P	= 5.6 mm	
T	= 118 sec.	

Material: Inconel 718 (Drill with internal coolant)		Load 24% S
Vc	= 40 m/min.	
S	= 750 r.p.m.	
fz	= 0.15 mm/tooth	
F	= 225 mm/min	
P	= 2.0 mm	
T	= 177 sec.	

2

NC Helix Drill

► Suggested insert grades for best result >>

Example 2	Diameter (mm)	25			
	Depth (mm)	50			
	Tool (Dc=17mm)	00-99321-016-2030 (external coolant)			
	Material		P Carbon Steel	M Stainless Steel	H Tool Steel
		DIN	C45E	X5CrNi18-10	X40CrMoV5 1
		SAE	1045	304	H13
		JIS	S45C	SUS304	SKD61 (HRC50°)
	Insert Grade	NC5072 (P40, TiAlN)	NC5072 (P40, TiAlN)	NC2032 (K20F, TiAlN)	
	No. of Edges	2	2	2	
	Vc = (m/min.)	120	60	80	
S = r.p.m.	2250	1120	1500		
fz = (mm/tooth)	0.1	0.065	0.05		
F = (mm/min.)	450	146	150		
Pitch = (mm)	5.6	3	3		
Machine Load = % (BT40, 22.5KW)	35%	20%	20%		
Tool Life (hole)	150	108	18		
Chip Removal Volume (cm³/min.)	52.66	8.55	8.77		

► To produce step hole Ø53.5 & Ø45 by one tool >>

Example 3

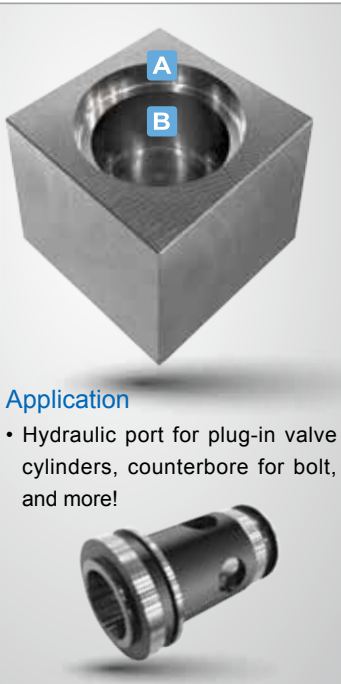

Application

- Hydraulic port for plug-in valve cylinders, counterbore for bolt, and more!

Material	S50C (JIS), High carbon steel									
Tool	99323-LS32-HD40 (Non-standard size)									
Insert	N9MX12T308-NC2032									
Machine	BT40, 22.5 Kw									
Coolant	Internal									
Hole	Dc mm	D mm	L mm	Vc m/min.	S r.p.m	fz mm/tooth	F mm/min.	I mm	P mm	T sec.
A	Ø40	Ø53.5	10	300	2400	0.08	380	6.75	5.0	13.3
B	Ø40	Ø45.0	32	300	2400	0.08	380	2.5	2.0	39.48

► Just one “NC Helix Drill” can machine different diameters and hole depths.

2

NC Helix Drill

► Just one tool to drill different diameters and hole depth, possible up to 6xDc >>

Example 4

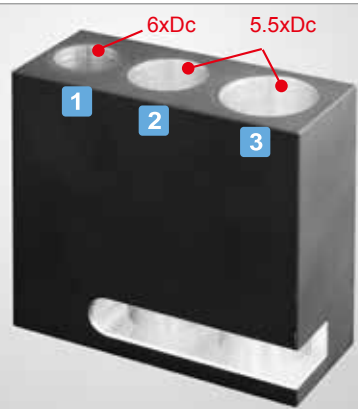

Material	AL6061T6										
Tool	00-99323-016-2030										
Insert	N9MX070204-NC5072										
Machine	HAAS VM-3, BT40, 22.5KW ($\eta=1$)										
Coolant	Internal coolant										
Fig.	Dc mm	D mm	I mm	L mm	Vc m/min.	S r.p.m	fz mm/tooth	fcut mm/min	F mm/min.	P mm	α deg
1		20	1.5	100	500	9360	0.04	0.058	1090	3	17.67
2	Ø17	25	4	95	500	9360	0.08	0.103	1930	4.5	10.16
3		30	6.5	95	500	9360	0.105	0.131	2450	5.6	7.81

► Low spindle power is not a problem!
BT30 machine, Ø30 hole diameter, 3.3xDc drill depth >>

The main purpose of this example is to improve machining efficiency.

Example 5



Maximum drilling capacity of the 5.5 kw spindle is Ø16 mm

Material	S50C (JIS), High carbon steel										
Tool	00-99321-020-2540 / BC20-HD22-2540										
Insert	N9MX100306-NC2032										
Machine	BT30, 5.5 KW ($\eta=0.7$)										
Coolant	External coolant										
Dc mm	D mm	L mm	Vc m/min.	S r.p.m	fz mm/tooth	fcut mm/min.	F mm/min.	I mm	P mm	T sec.	
Ø22	Ø30	60	200	* 2893	0.12	0.1	600	4	2.8	62	

* 3000 r.p.m. is used.

► Calculation: $f_{cut} = 0.12 \times 2 \times 0.7 \sqrt[3]{1 + \frac{2.8}{4}} = 0.1 \text{ mm/min.}$

* calculation formula please refer to p 2-8

▶ One tool performs multiple patterns >> (this is only programming example, no refer to cutting parameters)

Example 6								
		Material	AL6061T6					
		Tool	00-99323-016-2030 M08-HD17-2030					
		Insert	N9MX070204-NC5072					
		Machine	HAAS VM-3, BT40, 22.5KW					
		Coolant	Internal					
Fig.	Dc mm	Vc m/min.	S r.p.m	fz mm/tooth	F mm/min.	P mm	T sec.	
1		200	3800	0.075	570	4	67	
2	Ø17	200	3800	0.075	570	4	95	
3		200	3800	0.075	570	4	80	
Tool Path 								
<pre> % G40 G80 G69 G28 G91 Z0 G28 G91 X0 Y0 G00 G90 G126 G00 G90 X0. Y0. G52 X18. Y-20. G00 G90 X0. Y0. T5 M06 #1= 6.5 (X1) #11= -6.5 (X1=-) #6= 1.5 (X2) #7= -1.5 (X2=-) #2= 0. (Y) #3= 2.0 (Z1-1) #13= -2.0 (Z1-2) #16= -10.0 (Z1-1) #17= -12.0 (Z1-2) #4= 190.0 (F1-1) #5= 570.0 (F1-2) #14= 190.0 (F1-1) #15= 380.0 (F1-2) #8= 3 (L1=Depth/P#9) #9= 4.0 (P1=Z#3-DOWN Pitch) #18= 7 (L2=Depth/P#9) #19= 2.0 (P2=Z#16-DOWN Pitch) M88 G00 G90 X#1 Y#2 S3800 M03 G43 H05 Z30. (M08) Z10. Z5. G01 Z#3 F#4 M97 P1000 L#8 G03 I#11 F#4 G01 X#6 Y#2 (Holes 2) M97 P2000 L#18 G03 I#7 F#14 G01 X0. Y0. G00 G90 Z10. M05 G00 G90 Z20. M89 G00 G90 Z30. M09 G28 G91 Z0. M05 M00 G28 G91 Y0. M30 N1000 G03 I#11 Z#13 F#5 #13= #13 - #9 M99 N2000 G03 I#7 Z#17 F#15 #17= #17 - #19 M99 %</pre>		<pre> % G40 G80 G69 G28 G91 Z0 G28 G91 X0 Y0 G00 G90 G126 G00 G90 X0. Y0. G52 X0. Y0. G00 G90 X0. Y0. T5 M06 #12= 1.0 (Z-UP) #13= 0.0 (Z1) #14= -1.512 (Z2) #15= -2.608 (Z3) #16= -2.904 (Z4) #17= -4.0 (Z5-1) (Z2-1) #4= 190.0 (F1) #5= 570.0 (F2) #7= -6.5 (X2=-) #18= -12.0 (Z2-2) #19= 4.0 (P2=Z#17-DOWN PITCH) G00 G90 X25. Y-51. M88 S3800 M03 G43 H05 Z30. (M08) Z10. G01 Z#12 F#4 M97 P1000 L2 G01 X35.757 Y-55.924 F#4 G03 X35.757 Y-46.076 R-6.5 G02 X15.537 Y-49.599 R20. G03 X15.537 Y-52.401 R-1.5 G02 X35.757 Y-55.924 R20. G01 X46.5 Y-51. M97 P2000 L3 G03 I#7 F#4 G01 X40. Y-51. G00 G90 Z10. M05 G00 G90 Z20. M89 G00 G90 Z30. M09 G28 G91 Z0. M05 M00 G28 G91 Y0. M30 N1000 G01 X35.757 Y-55.924 Z#13 F#4 G03 X35.757 Y-46.076 R-6.5 Z#14 F#5 %</pre>			<pre> % G40 G80 G69 G28 G91 Z0 G28 G91 X0 Y0 G00 G90 G126 G00 G90 X0. Y0. G52 X0. Y0. G00 G90 X0. Y0. T5 M06 #1= 4.0 (Z up) #2= 0.0 (Z1) #3= -4.0 (Z2) #4= 210.0 (F1) #5= 420.0 (F2) #6= 4.0 (Z#13-Pitch) G00 G90 X92.56 Y-14.507 M88 S2800 M03 G43 H05 Z30. (M08) Z10. Z5. M97 P1000 L5 (Z-Pitch) G00 G90 Z30. M05 M09 M89 G28 G91 Z0. M05 M00 G28 G91 Y0. M30 N1000 G00 G90 X92.56 Y-14.507 G01 Z#1 F#4 G02 X108.5 Y-20.416 Z#2 R72. F#5 G03 X92.56 Y-14.507 Z#3 R72. F#5 G01 Z#2 G03 X75.679 Y-12.5 Z#3 R72. F#5 G01 Z#2 G03 X58.798 Y-14.507 Z#3 R72. F#5 G01 Z#2 G03 X42.858 Y-20.416 Z#3 R72. F#5 G01 Z#2 G00 G90 Z5. #1= #1 - #6 (Z up) #2= #2 - #6 (Z1.) #3= #3 - #6 (Z2.) M99 %</pre>			



Super Power Drill

5xD ~ 10xD

3

Ø19mm ~ Ø40mm

Super Power Drill

It is no doubt that deep hole drilling by indexable drill is always a challenge of the drill makers.

Nine9 “Super Power Drill”, featuring by patented indexable center pilot insert design, which is the first time in the world, helping to achieve the cost-effective and good performance, making deep hole drilling up to 12xD possible.

With patented center pilot insert which aids accurate and steady deep hole drilling. Better finished surface, and possible reduce your boring process.



Deep Hole Drilling

up to 12xD

Indexable drills with
carbide center
pilot insert

- Better surface finish
- Better straightness
- Better roundness

3

Super Power Drill

Application



Heat Exchanger



Semi-finished Product



Pressure Vessel



Oil & Gas



Military

Insert

Center Pilot Insert

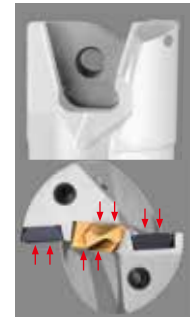

Patented pocket design

► Features >>

- Special geometry design delivers the benefits of the center drill in guiding position and eliminates the defects caused by the chip flow from the gap between the center drill and insert.
- High precision fully ground and edge honing to increase tool life and surface finish.
- Patented insert pocket to absorb the cutting forces, supporting the center pilot insert functional while drilling.

NC2032 : K20F grade, AlTiN coated, fully ground, honed cutting edge.
For carbon steel & alloy steel C<0.3% and stainless steel.

NC40 : P35 grade, TiN coated, fully ground, honed cutting edge.
For carbon steel & alloy steel C>0.3% and stainless steel.

Parts No.	Coating	Grade	Image	Dimensions		Screw	Key	
				Ød	S			
99307-CD6	NC40	TiN	P35		6	4	NS-35080 2.5Nm	NK-T15
	NC2032	AlTiN	K20F					
99307-CD8	NC40	TiN	P35		8	6	NS-35120 2.5Nm	NK-T15
	NC2032	AlTiN	K20F					

3

Super Power Drill

Periphery Insert

► Features >>

- Fully ground carbide insert
- Each insert has 4 cutting edges.
- Patented Dual-relief angle insert are designed for optimum chip breaking and good edge preparation for longer tool life.



NC2032: K20F grade, AlTiN coated, honed cutting edge for carbon steel, alloy steel, casting iron, stainless steel and hardened steel up to HRC 50.





NC40 : P35 grade, tougher insert with special chip breaker, TiN coated, for low carbon steel and stainless steel. Only available for insert N9GX06020431 and N9GX09030831.

Parts No.	Coating	Grade	Image	Dimensions			Screw	Key	
				L	S	re			
N9GX04T002	NC2032	AlTiN	P35		4.07	1.8	0.2	NS-18037 0.6Nm	NK-T6
N9GX05T103	NC2032	AlTiN	P35		5.07	2.0	0.3	NS-20045 0.6Nm	NK-T6
N9GX060204	NC2032	AlTiN	P35		6.35	2.38	0.4	NS-22062 0.9Nm	NK-T7
N9GX06020431	NC40	TiN	K20F		6.35	2.38	0.4		
N9GX090308	NC2032	AlTiN	P35		9.52	3.18	0.8	NS-30072 2.0Nm	NK-T9
N9GX09030831	NC40	TiN	K20F		9.52	3.18	0.8		

*Torque screwdriver is recommended, see page 6-4.

► NC Spot Drill + Super Power Drill Apply on Stationary Machine Tool >>

To get the perfect drilling operation

Step 1	Tool: 99616-14-12-02S to make a spot.		To get better position accuracy and diameter tolerance first, and make sure the size of the spot according to following.	
			Pilot Insert	99307-CD6 99307-CD8
Step 2	Tool: 99307-20200 to make a 10xD deep hole.		Then the spot hole will guide the pilot insert at the beginning and stabilized the drill to get the perfect drilling operation.	
			Spotting Diameter	ø5 mm ø7 mm
			Spotting Depth	2.8 mm 3.8 mm
Result	Cutting Speed	Feed rate	Surface	
Without spotting	Vc= 80 m/min.	f = 0.1 mm/rev.		
With spotting	Vc= 120 m/min. ↑	f = 0.1 mm/rev.		Finished surface is better and accurate. 

► Good surface finish >>





Center Pilot Insert	Material:Carbon steel (S45C)		
99307-CD8-NC40 N9GX060204-NC2032	Vc	80	m/min.
	S	880	r.p.m.
	f	0.10	mm/rev.
	F	88.0	mm/min.
	Ra	2.139	µm
	Rmax	11.8	µm



```
Perthometer M1
Object
Plane
...
t 5.600 mm
s Standard 2.5 µm
c 0.800 mm
a 2.139 µm
z 10.6 µm
max 11.8 µm
Pc(0.5,-0.5) 103 /c
Profile
c_ 0.600 mm
```

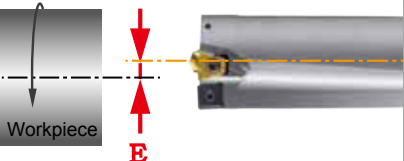

► Attention >> Please pay attention to following conditions before you start.

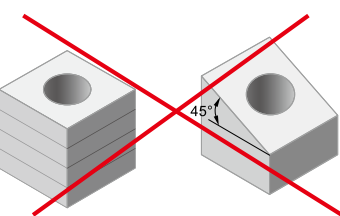
 1	 2	 3
<p>Center misalignment</p> <p>E must be < 0.05mm.</p> 	<p>Internal coolant</p> <p>High volume is recommended. Minimum coolant pressure is 10 bar.</p> 	<p>Application of drilling</p> <p>Not apply for stack drilling and angled surface drilling.</p> 

Holder

19mm~40mm

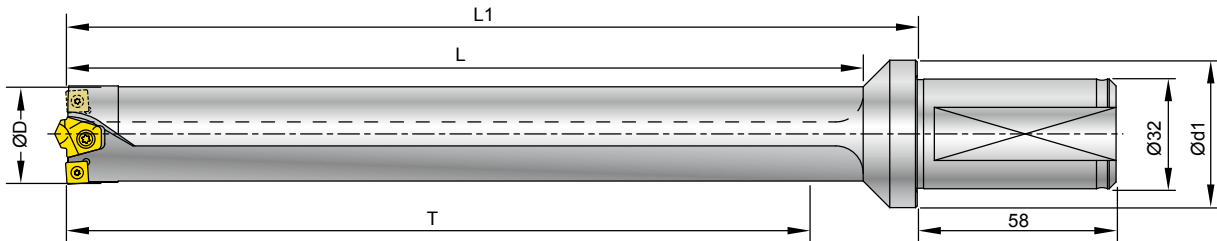









Parts No.	ØD mm (inch)	T	L	L1	Ød1	Insert / Screw / Key	
						Center	Periphery
00-99307-19100	19 (0.748")	100	119	134	39		N9GX04T002 x 1 pc. *NS-18037 / 0.6Nm NK-T6
00-99307-19150		150	169	184			
00-99307-19200		200	219	239			
00-99307-20100	20 (0.787")	100	120	134	39		N9GX05T103 x 1 pc. *NS-20045 / 0.6Nm NK-T6
00-99307-20150		150	170	184			
00-99307-20200		200	220	239			
00-99307-21100	21 (0.827")	100	120	134	39		NK-T6
00-99307-21150		150	170	184			
00-99307-21200		200	220	239			
00-99307-22100	22 (0.866")	100	125	139	39	99307-CD6 x 1 pc.	
00-99307-22150		150	175	189			
00-99307-22200		200	225	239			
00-99307-23100	23 (0.905")	100	125	139	39	NS-35080 2.5Nm	N9GX060204 x 1 pc. *NS-22062 / 0.9Nm NK-T7
00-99307-23150		150	175	189			
00-99307-23200		200	225	239			
00-99307-24100	24 (0.945")	100	126	139	39	NK-T15	
00-99307-24150		150	176	189			
00-99307-24200		200	226	239			
00-99307-24250	250	276	289				
00-99307-25100	25 (0.984")	100	126	139	39		
00-99307-25150		150	176	189			
00-99307-25200		200	226	239			
00-99307-25250	250	276	289				
00-99307-26150	26 (1.024")	150	176	189	39		
00-99307-26200		200	226	239			
00-99307-26250		250	276	289			
00-99307-27150	27 (1.630")	150	181	198	43	99307-CD8 x 1 pc.	N9GX060204 x 2 pcs. *NS-22062 / 0.9Nm NK-T7
00-99307-27200		200	231	248			
00-99307-27250		250	281	298			
00-99307-28150	28 (1.102")	150	181	198	43	NS-35120 2.5Nm	NK-T15
00-99307-28200		200	231	248			
00-99307-28250		250	281	298			
00-99307-29150	29 (1.142")	150	182	198	43		
00-99307-29200		200	232	248			
00-99307-29250		250	282	298			
00-99307-29300		300	332	348			

*Torque screwdriver is recommended, see page 6-4.

3

Super Power Drill



Parts No.	ØD mm(inch)	T	L	L1	Ød1	Insert / Screw / Key	
						Center	Periphery
00-99307-30150	30 (1.181")	150	182	198	43		
00-99307-30200		200	232	248			
00-99307-30250		250	282	298			
00-99307-30300		300	332	348			
00-99307-31150	31 (1.220")	150	188	198	43		
00-99307-31200		200	238	248			
00-99307-31250		250	288	298			
00-99307-31300		300	338	348			
00-99307-32150	32 (1.260")	150	188	203	43		 N9GX060204 x 2 pcs.
00-99307-32200		200	238	253			
00-99307-32250		250	288	303			
00-99307-32300		300	338	353			
00-99307-33150	33 (1.300")	150	189	203	43		 *NS-22055 0.9Nm  NK-T7
00-99307-33200		200	239	253			
00-99307-33250		250	289	303			
00-99307-33300		300	339	353			
00-99307-34150	34 (1.339")	150	189	203	43		
00-99307-34200		200	239	253			
00-99307-34250		250	289	303			
00-99307-34300		300	339	353			
00-99307-34350		350	389	403			
00-99307-35200	35 (1.378")	200	245	258	43		 99307-CD8 x 1 pc.
00-99307-35250		250	295	308			
00-99307-35300		300	345	358			
00-99307-35350		350	395	408			
00-99307-36200	36 (1.417")	200	245	258	43		 NS-35120 2.5Nm  NK-T15
00-99307-36250		250	295	308			
00-99307-36300		300	345	358			
00-99307-36350		350	395	408			
00-99307-37200	37 (1.457")	200	246	258	43		 N9GX090308 x 2 pcs.
00-99307-37250		250	296	308			
00-99307-37300		300	346	358			
00-99307-37350		350	396	408			
00-99307-38200	38 (1.496")	200	246	258	43		 NS-30072 2.0Nm  NK-T9
00-99307-38250		250	296	308			
00-99307-38300		300	346	358			
00-99307-38350		350	396	408			
00-99307-39200	39 (1.535")	200	247	258	43		
00-99307-39250		250	297	308			
00-99307-39300		300	346	358			
00-99307-39350		350	397	408			
00-99307-40200	40 (1.575")	200	247	258	43		
00-99307-40250		250	297	308			
00-99307-40300		300	347	358			
00-99307-40350		350	397	408			

3

Super Power Drill

Machining Power Requirement for Drilling

5xD~10xD

Material Classification for Calculation

There are an extremely wide range of materials and different machining operations in the metal cutting industry. We follow the ISO material group and color to make brief information for calculation of the required power for super power drill, the main effective parameter is “specified cutting force”, please use following table and formula.

Material Group	Material Type and description	Hardness HB	Strength N/mm ²	Specified cutting force kc N/mm ²
P	1.10 Carbon steel C<0.3%, free cutting steels	~125	500-850	1900
	1.20 Carbon steel C>0.3%	~150	850-1000	2100
	1.30 Low alloy steel C<0.3%	180	Up to 750	2100
	1.40 Low alloy steel C>0.3%	200	750-1200	2600
	1.50 High alloy steel	200	800-1200	2600
	1.60 Tool steel, harder steels for toughening. Martensitic stainless steels.	<230	850-1100	2200
	1.70 Casting steel			2900
M	2.10 Free cutting Stainless steel Austenitic stainless steels	200	490-700	2300
	2.20 Difficult Stainless steel Austenitic stainless steels and duplex	175	650-850	2450
K	3.10 Grey casting iron	180	250-350	1100
	3.20 Malleable casting iron..	230	Up to 600	1200
	3.30 Nodular casting iron	250	Up to 800	1800
N	4.10 Al- alloys(Si<12%)	60	230-310	500
	4.20 Al-alloys(Si>12%)	75	150-200	750
	4.30 Non-ferrous materials, Zirconium, Magnesium, Copper alloys, etc.	100	150-200	800
	4.40 Carbon and graphite composites, plastics, wood, rubbers, etc.	—	—	—
S	5.10 Nickel-based heat-resistant alloys	250		3500
	5.20 Cobalt-based heat resistant alloys	350		4150
	5.30 Iron-based heat resistant alloys	250		3050
H	6.10 Tool steels and hardened steels	55HRC		4500
	6.20 Hardened cast iron	—	—	—

Formulas for Calculation of Machining Power Pc(Kw)

$Pc(Kw) = \frac{f \times Vc \times D \times Kc}{60 \times 10^3 \times \eta}$	Drilling torque (Md) torque=(Nm) $Md = \frac{f \times \pi \times D^2 \times Kc}{4000} \text{ Nm}$	f = feed rate	mm/rev.
feed force(KN) Ff $Ff = \frac{ap \times f \times Kc}{2000}$		Vc = cutting speed	m/min.
		D = drill diameter	mm
		Kc = specified cutting force	N/mm ²
		η = power transmission efficiency of spindle	(75%-85%)

3

Super Power Drill

Technical Guide

Internal coolant is required.

The coolant is feed directly into the inserts cutting face, cooling the top of the drill and preventing chip adhesion, which allows for quick and smooth chip evacuation.

Cutting Data

Work piece material	T= Length/ Dia.	Vc (m/min.)	f (mm/rev.)				Grade of insert		
			N9GX04T002	N9GX05T103	N9GX060204	N9GX090308	Center	Periphery	
			Dia.19	Dia.20-21	Dia.22-34	Dia.35-40			
P Carbon steel C<0.3% Ex.:S25C, SS41	T<7D	80~150	0.03~0.07	0.04~0.08	0.06~0.10	0.08~0.12	NC2032	NC2032	
	T>7D	60~120	0.03~0.07	0.04~0.08	0.06~0.10	0.08~0.12			
	T<7D	80~130	—	—	0.06~0.10	0.08~0.12	NC40	NC40	
	T>7D	60~100	—	—	0.06~0.10	0.08~0.12			
	Carbon steel C>0.3% Ex.:S50C, P5	T<7D	80~150	0.04~0.08	0.04~0.10	0.06~0.12	0.08~0.15	NC40	NC2032
		T>7D	60~120	0.04~0.08	0.04~0.10	0.06~0.12	0.08~0.15		
	Low alloy steel C<0.3% Ex.:SCM415	T<7D	60~150	0.04~0.08	0.04~0.10	0.06~0.10	0.08~0.12	NC2032	NC2032
		T>7D	40~120	0.04~0.08	0.04~0.10	0.06~0.10	0.08~0.12		
	Low alloy steel C>0.3% Ex.:SCM440	T<7D	60~150	0.04~0.08	0.04~0.10	0.06~0.12	0.08~0.15	NC40	NC2032
		T>7D	40~120	0.04~0.08	0.04~0.10	0.06~0.12	0.08~0.15		
	High alloy steel Ex.:SKD11	T<7D	60~120	0.03~0.07	0.04~0.08	0.06~0.10	0.08~0.12	NC40	NC2032
		T>7D	40~100	0.03~0.07	0.04~0.08	0.06~0.10	0.08~0.12		
Casting steel	T<7D	60~120	0.03~0.07	0.04~0.08	0.06~0.10	0.08~0.12	NC40	NC2032	
	T>7D	40~100	0.03~0.07	0.04~0.08	0.06~0.10	0.08~0.12			
M Stainless steel Ex.:SUS304	T<7D	60~120	0.03~0.06	0.04~0.07	0.05~0.08	0.06~0.10	NC2032	NC2032	
	T>7D	40~100	0.03~0.06	0.04~0.07	0.05~0.08	0.06~0.10			
	T<7D	60~120	—	—	0.05~0.08	0.06~0.10	NC40	NC40	
	T>7D	40~100	—	—	0.05~0.08	0.06~0.10			
K Casting Iron Ex.:FC25	T<7D	60~120	0.04~0.08	0.04~0.10	0.06~0.10	0.08~0.12	NC40	NC2032	
	T>7D	40~100	0.04~0.08	0.04~0.10	0.06~0.10	0.08~0.12			
N Al, and non-ferrous metal Ex.:A6061	—	—	—	—	—	—	—	—	
	—	—	—	—	—	—	—	—	
S Hardened steel <HRC 50° Ex.:SKD61	T<7D	50~80	0.03~0.06	0.04~0.07	0.05~0.08	0.06~0.10	NC40	NC2032	
	T>7D	40~60	0.03~0.06	0.04~0.07	0.05~0.08	0.06~0.10			



Important Information

- Recommend to make a spot hole first by spot drill. See page 3-4 for detail.
- The cutting speed relates to the periphery inserts, The feed rate depends on the load of the center pilot insert.
- The best condition will create short cutting chips. The feed rate can be applied ± 25% of the recommended value depended on the shape of the cutting chips.
- Be careful to monitor the spindle power consumption !
When the spindle load is 15% higher than starting power consumption, please change the periphery insert to next new cutting edge and change a new center pilot insert.
- Minimum coolant pressure is 10 bar (about 150 psi.).
- Increase 20% of the cutting speed and the feed rate for horizontal spindle machine.
- For the CNC lathes, maximum miss-alignment of drill center and spindle center is ±0.05 mm, it is not necessary to drill center hole in advance.



Super Drill

3xD & 4xD

Ø10mm ~ Ø30mm

3

SMALLEST DIMENSION

3xD : Ø10 to Ø30 mm

4xD : Ø16 to Ø30 mm

SMALLER CUTTING CHIP

- The center and peripheral inserts are positioned in order to divide the cutting chips into smaller spiral shape. It helps the cutting chip to be removed faster and easier.
- Designed for high productivity, high speed cutting. Coolant supply is needed.

BETTER SURFACE FINISH AND BETTER DIAMETER ACCURACY

- Special insert positioning to balance the cutting forces, better surface finish and diameter accuracy are achievable.



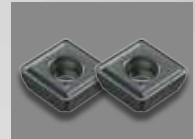

4 cutting edges insert
AlTiN coated

Chip breaker of SD insert provides excellent chip control property due to its engineered design
Easy and simple change of cutting edge without inconvenience



≈ Flat bottom shape



Angled Surfaces

Possible to drill into angled surfaces without pre-drilling

3

Super Drill

- Smallest indexable drill from 10mm.
- 4 cutting edges per insert, same insert for outer and inner insert.

Insert

Features

- Fully ground dual-relief insert, for improved surface finish and higher feed rate.
- Primary relief angle is to increase the toughness of the insert, secondary relief angle is to strengthen the axial feed rate.
- Same insert for outer and inner insert.
- Square insert with 4 cutting edges, reducing cost per insert.
- Better surface finish.
- Better diameter accuracy.



NC2032

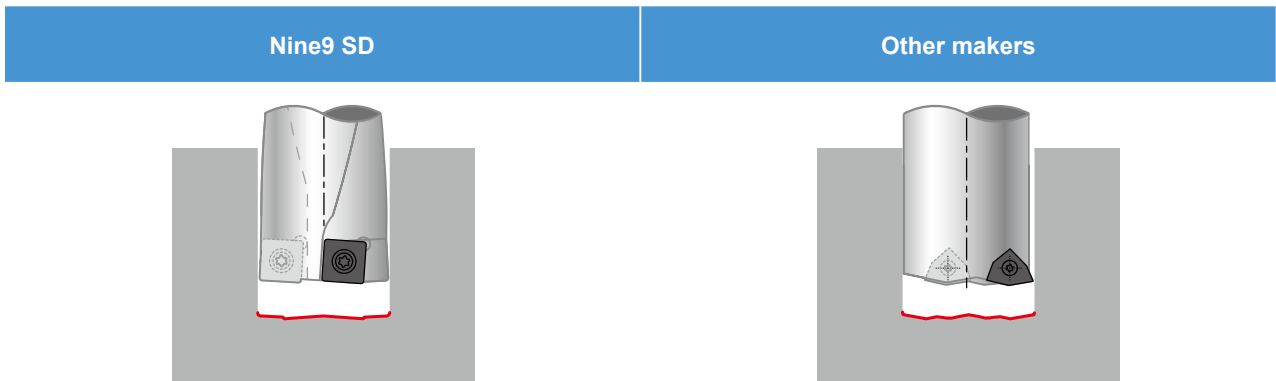

3

Super Drill

NC2032: K20F grade, AlTiN coated, for carbon steel, alloy steel, casting iron, stainless steel and hardened steel up to HRC 50.

Parts No.	Coating	Grade		Dimensions			Screw	Key
				L	S	re		
N9GX04T002	NC2032	AlTiN	K20F	4.07	1.8	0.2	*NS-18037 0.6Nm	NK-T6
N9GX05T103	NC2032	AlTiN	K20F	5.07	2.0	0.3	*NS-20045 0.6Nm	NK-T6
N9GX060204	NC2032	AlTiN	K20F	6.35	2.38	0.4	*NS-22055 0.9Nm	NK-T7
N9GX070304	NC2032	AlTiN	K20F	7.94	3.18	0.4	*NS-25060 0.9Nm	NK-T7
N9GX090308	NC2032	AlTiN	K20F	9.52	3.18	0.8	NS-30072 2.0Nm	NK-T9

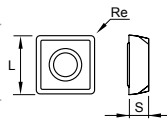

*Torque screwdriver is recommended, see page 6-4.

Holder 3xD 10mm~30mm

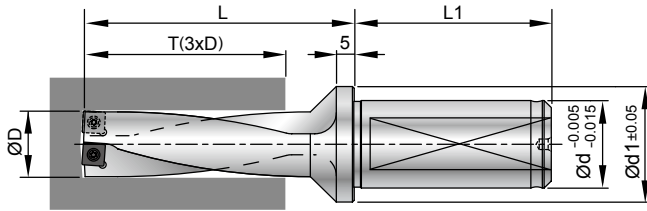

Parts No.	ØD	T	L	L1	Ød	Ød1	Insert Screw / Key	Radial Adjustment	D max
00-99313-10	10.0	30.0	49	49	20	27		0.25	10.5
00-99313-10.3	10.3	30.9	52	49	20	27		0.25	10.8
00-99313-10.5	10.5	31.5	52	49	20	27	N9GX04T002	0.25	11.0
00-99313-11	11.0	33.0	52	49	20	27	*NS-18037	0.20	11.4
00-99313-11.5	11.5	34.5	55	49	20	27	0.6Nm	0.20	11.9
00-99313-12	12.0	36.0	55	49	20	27	NK-T6	0.15	12.3
00-99313-12.5	12.5	37.5	58	49	20	27		0.15	12.8
00-99313-13	13.0	39.0	58	49	20	27		0.30	13.6
00-99313-13.5	13.5	40.5	61	49	20	27	N9GX05T103	0.30	14.1
00-99313-14	14.0	42.0	61	49	20	27		0.25	14.5
00-99313-14.5	14.5	43.5	64	49	20	27	*NS-20045	0.25	15.0
00-99313-15	15.0	45.0	64	49	20	27	0.6Nm	0.20	15.4
00-99313-15.5	15.5	46.5	67	49	20	27	NK-T6	0.20	15.9
00-99313-16	16.0	48.0	74	55	25	31		0.40	16.8
00-99313-16.5	16.5	49.5	76	55	25	31		0.40	17.3
00-99313-17	17.0	51.0	76	55	25	31		0.35	17.7
00-99313-17.5	17.5	52.5	78	55	25	31	N9GX060204	0.35	18.2
00-99313-18	18.0	54.0	78	55	25	31		0.30	18.6
00-99313-18.5	18.5	55.5	80	55	25	31	*NS-22055	0.30	19.1
00-99313-19	19.0	57.0	80	55	25	31	0.9Nm	0.30	19.5
00-99313-19.5	19.5	58.5	85	55	25	31	NK-T7	0.25	19.5
00-99313-20	20.0	60.0	85	55	25	31		0.25	20.0
00-99313-20.5	20.5	61.5	87	55	25	31		0.50	21.0
00-99313-21	21.0	63.0	87	55	25	31		0.50	21.5
00-99313-21.5	21.5	64.5	88	55	25	31	N9GX070304	0.45	21.9
00-99313-22	22.0	66.0	88	55	25	31		0.45	22.4
00-99313-22.5	22.5	67.5	90	55	25	31	*NS-25060	0.40	22.8
00-99313-23	23.0	69.0	90	55	25	31	0.9Nm	0.40	23.3
00-99313-23.5	23.5	70.5	92	55	25	31	NK-T7	0.40	23.7
00-99313-24	24.0	72.0	92	55	25	31		0.35	23.7
00-99313-25	25.0	75.0	92	55	25	31		0.35	24.2
00-99313-26	26.0	78.0	114	58	32	43		0.35	24.2
00-99313-27	27.0	81.0	115	58	32	43		0.30	24.6
00-99313-28	28.0	84.0	117	58	32	43	N9GX090308	0.50	26.0
00-99313-29	29.0	87.0	127	58	32	43		0.50	27.0
00-99313-30	30.0	90.0	130	58	32	43	NS-30072	0.40	27.8
							2.0Nm	0.40	28.8
							NK-T9	0.30	29.6
								0.30	30.6

*Torque screwdriver is recommended, see page 6-4.

Holder 4xD 16mm~30mm

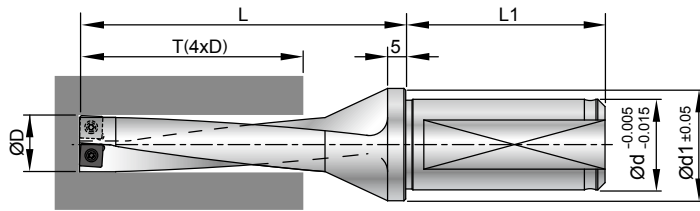

Parts No.	ØD	T	L	L1	Ød	Ød1	Insert Screw / Key	Radial Adjustment	D max
00-99314-16	16	64	90	55	25	31	N9GX060204	0.40	16.8
00-99314-17	17	68	93	55	25	31	*NS-22055 0.9Nm	0.35	17.7
00-99314-18	18	72	96	55	25	31	NK-T7	0.30	18.6
00-99314-19	19	76	99	55	25	31		0.25	19.5
00-99314-20	20	80	105	55	25	31	N9GX070304	0.50	21.0
00-99314-21	21	84	108	55	25	31		0.45	21.9
00-99314-22	22	88	110	55	25	31	*NS-25060 0.9Nm	0.40	22.8
00-99314-23	23	92	113	55	25	31	NK-T7	0.35	23.7
00-99314-24	24	96	116	55	25	31		0.30	24.6
00-99314-25	25	100	139	58	32	43		0.50	26.0
00-99314-26	26	104	141	58	32	43	N9GX090308	0.50	27.0
00-99314-27	27	108	144	58	32	43		0.40	27.8
00-99314-28	28	112	154	58	32	43	NS-30072 2.0Nm	0.40	28.8
00-99314-29	29	116	156	58	32	43	NK-T9	0.30	29.6
00-99314-30	30	120	160	58	32	43		0.30	30.6

*Torque screwdriver is recommended, see page 6-4.

3

Super Drill

Application of Drill in Different Conditions

Material Classification for Calculation

Application	* Regular Surface	Cross Holes	Stack Drilling	Round Work Piece Offset Drilling
Work Piece Shape				
Cutting Speed Vc (m/min.)	100%	80%	80%~70%	80%~60%
Feed Rate (mm/rev.)	100%	80%	80%~70%	80%~60%
Application	Plunge Drilling	Concave Surfaces	Angled Surfaces	Cone Work Piece Offset Drilling
Work Piece Shape				
Cutting Speed Vc (m/min.)	80%	80%	80%~70%	80%~70%
Feed Rate (mm/rev.)	80%	80%	80%~70%	80%~70%

* SPD, SD both are suitable.

Technical Guide

Cutting Data

Work piece material	T= Length/ Dia.	Vc (m/min.)	f (mm/rev.)					Grade of insert	
			N9GX 04T002	N9GX 05T103	N9GX 060204	N9GX 070304	N9GX 090308		
			Dia. 10~12.5	Dia. 13~15.5	Dia. 16~19.5	Dia. 20~24	Dia. 25~30		
P Carbon steel C<0.3% Ex.:S25C, SS41	T=3D	80~250	0.03~0.06	0.04~0.08	0.06~0.10	0.06~0.10	0.08~0.12	NC2032	
	T=4D	60~180	—	—	0.06~0.10	0.06~0.10	0.08~0.12		
	Carbon steel C>0.3% Ex.:S50C, P5	T=3D	80~300	0.04~0.08	0.06~0.10	0.06~0.12	0.08~0.12	0.08~0.15	NC2032
		T=4D	60~150	—	—	0.06~0.12	0.08~0.12	0.08~0.15	
	Low alloy steel C<0.3% Ex.:SCM415	T=3D	80~250	0.04~0.08	0.04~0.08	0.06~0.10	0.06~0.10	0.08~0.12	NC2032
		T=4D	60~150	—	—	0.06~0.10	0.06~0.10	0.08~0.12	
Low alloy steel C>0.3% Ex.:SCM440	T=3D	80~250	0.04~0.08	0.04~0.10	0.06~0.12	0.06~0.12	0.08~0.15	NC2032	
	T=4D	60~150	—	—	0.06~0.12	0.06~0.12	0.08~0.15		
High alloy steel Ex.:SKD11	T=3D	60~150	0.03~0.06	0.04~0.08	0.06~0.10	0.06~0.10	0.08~0.12	NC2032	
	T=4D	50~100	—	—	0.06~0.10	0.06~0.10	0.08~0.12		
Casting steel	T=3D	80~180	0.03~0.06	0.04~0.08	0.06~0.10	0.06~0.10	0.08~0.12	NC2032	
	T=4D	60~120	—	—	0.06~0.10	0.06~0.10	0.08~0.12		
M Stainless steel Ex.:SUS304	T=3D	60~150	0.03~0.06	0.04~0.08	0.04~0.10	0.06~0.10	0.06~0.12	NC2032	
	T=4D	50~100	—	—	0.04~0.10	0.06~0.10	0.06~0.12		
K Casting Iron Ex.:FC25	T=3D	80~120	0.04~0.08	0.06~0.08	0.06~0.08	0.06~0.10	0.08~0.12	NC2032	
	T=4D	60~100	—	—	0.06~0.08	0.06~0.10	0.08~0.12		
S Hardened steel <HRC 50° Ex.:SKD61	T=3D	60~100	0.03~0.06	0.04~0.08	0.05~0.08	0.06~0.08	0.06~0.10	NC2032	
	T=4D	40~80	—	—	0.05~0.08	0.06~0.08	0.06~0.10		

* The maximum misalignment of the drill center is +0.2 mm/-0.5 mm on the CNC lathe.

Metric	
$S = \frac{Vc \times 1000}{\pi \times d}$	d = diameter -mm S = Spindle Speed -r.p.m. Vc = Cutting Speed -m/min.
F = S x f	f = mm/rev. F = mm/min.

Inch	
$S = \frac{(3.82 \times SFM)}{d}$	d = diameter-inch S = Spindle Speed-r.p.m. SFM = Surface Speed-ft./min. Vc (m/min.) x 3.28
F = f x S	f = IPR = inch/rev. F = IPM=RPM x f / 25.4

3

Super Drill



Power Mill

Indexable milling cutter 10mm.
Patented Dual Relief Angle Insert!
Higher feed rate. Higher wearing resistance!

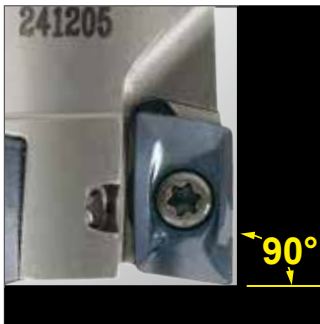

A Series- Shoulder Face Mills

Dia. range: Ø10 ~ Ø25mm

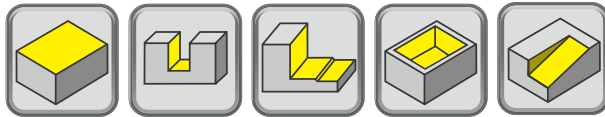

C Series- Torus Radius Mills

Dia. range: Ø10 ~ Ø26mm

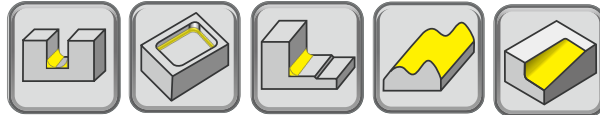

R Series- Round Insert Mills

Dia. range: Ø16 ~ Ø100mm

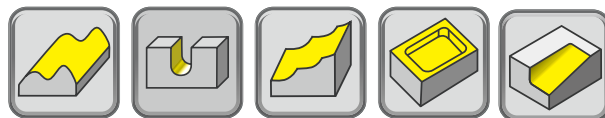

Face Mills

Dia. range: Ø32 ~ Ø315mm

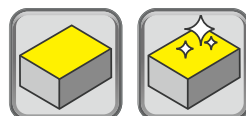

4

Power Mill



Modular Power Mill System

A Series Shoulder Face Mills

Ø10-Ø25
 99802-BC..A..

Ø20 & Ø25
 99522..

Ø10-Ø25
 99802-M..A..
 99805-M..A..

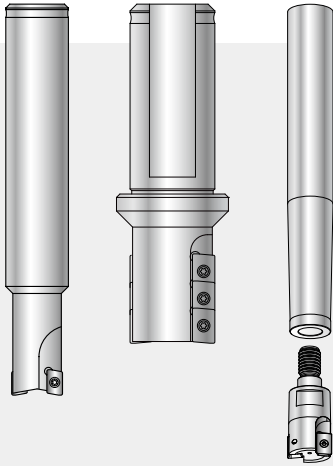



 A9MT06...
 A9MT10...

C Series Torus Radius Mills

Ø12-Ø25
 99802-BC..C..

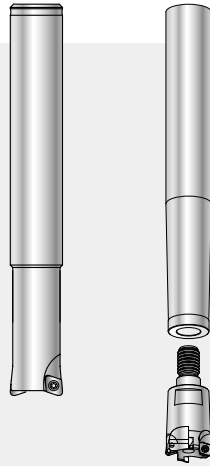
Ø10-Ø26
 99802-M..C..
 99805-M..C..





 C9MT04...
 C9MT15...

R Series Round Insert Mills

Ø16-Ø35
 99802-BC..R..

Ø50-Ø100
 99802-MC..R..

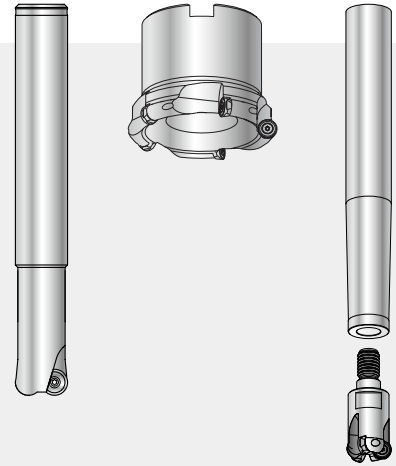
Ø16-Ø35
 99802-M..R..



 R9MT08...

4

Power Mill

Indexable 16 cutting edge insert face mills

Ø32
 99542-032 (Roughing)

Ø50-Ø125
 99542-... (CW)
 99542-... L (CCW)

Ø63, Ø80 and Ø100
 99543-063
 99543-080
 99543-100
 (High speed)

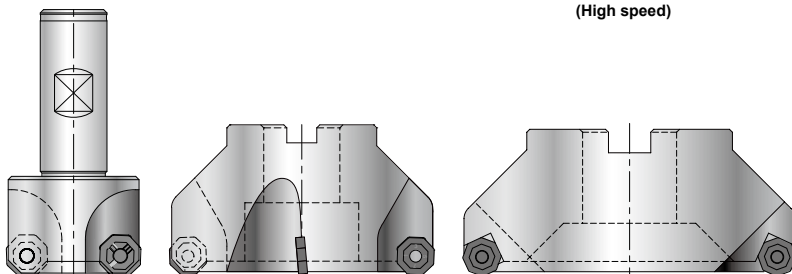

 N9GJ11T3F2-0

Aluminium alloy face mills

Ø80-Ø315mm
 99511-...

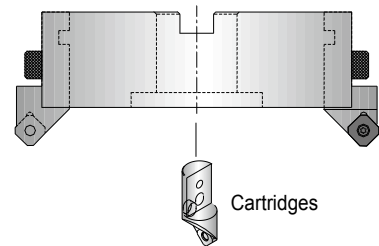

 N9MT11T3HR300
Mirror milling

 N9GJ11T3F2
Mirror milling

A Series Shoulder Face Mills

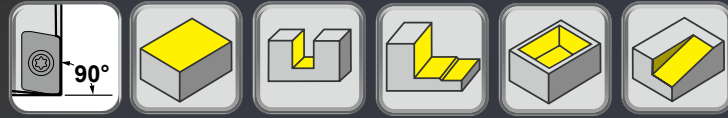
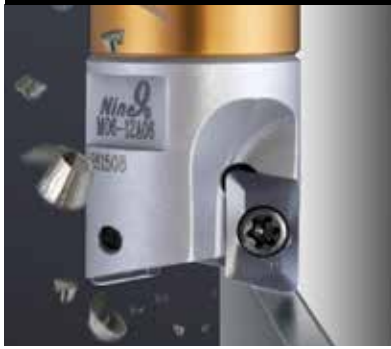

Features:

- Strong insert with high positive geometry and helical cutting edges.
- Shoulder mill with good cutting performance and cutting edge strength.

Holder

► Cylindrical Shank

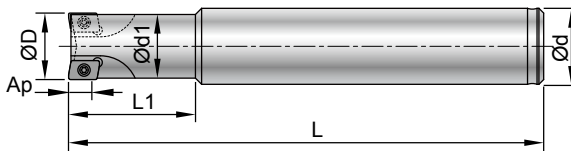
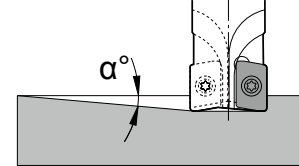

Part No.	Type	ØD	No. of teeth	Ød h6	Ød1	α°	Ap	L1	L	Insert type
00-99802-BC10-10A06	BC10-10A06-100	10	2	10	9.8	5.0	5	40	100	A9...0602...
00-99802-BC12-10A06	BC12-10A06-80	10	2	12	9.8	5.0	5	20	80	
00-99802-BC12-11A06	BC12-11A06-80	11	2	12	10.8	4.5	5	22	80	
00-99802-BC12-12A06	BC12-12A06-80	12	2	12	11.4	4.0	5	24	80	
00-99802-BC16-13A06	BC16-13A06-100	13	2	16	12.4	3.5	5	26	100	
00-99802-BC16-14A06	BC16-14A06-100	14	2	16	13.4	3.0	5	28	100	
00-99802-BC16-15A06	BC16-15A06-100	15	3	16	14.4	2.5	5	30	100	
00-99802-BC16-16A06	BC16-16A06-100	16	3	16	15.4	2.0	5	32	100	A9...1035...
00-99802-BC16-16A10	BC16-16A10-100	16	2	16	14.5	2.5	9	32	100	
00-99802-BC20-20A10	BC20-20A10-120	20	3	20	18.5	2.0	9	40	120	
00-99802-BC25-25A10	BC25-25A10-150	25	3	25	23.5	1.3	9	50	150	

► Helical mills

- Side lock shank.
- For used on BT40.

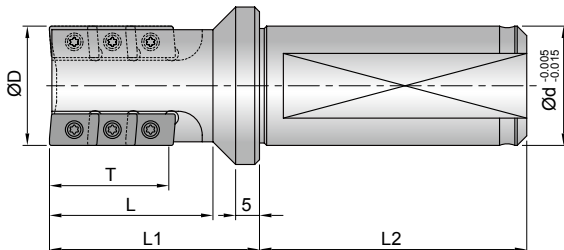

Part No.	Type	ØD	No. of teeth	Ød	T	L	L1	L2	Insert type
00-99522-20	SB20-EM20x3T	20	3	20	18	24.5	35	50	A9..1035...
00-99522-25	SB25-EM25x6T	25	6	25	25	34.25	44	56	

A Series Shoulder Face Mills

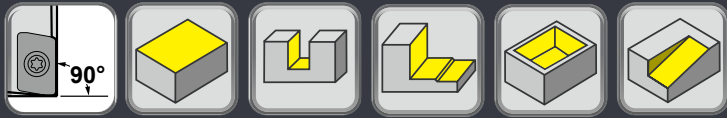

Holder

► Screw-Fit Type

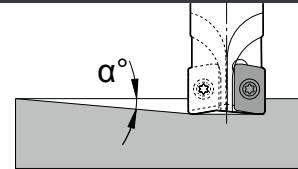
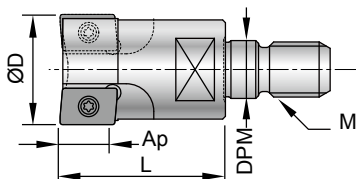

Part No.	Type	ØD	No. of teeth	α°	Ap	L	M	DPM	Insert type
00-99805-M05-10A06	M05-10A06	10	2	5.0	5	13	M5xP0.8	5.5	A9...0602...
00-99805-M05-11A06	M05-11A06	11	2	4.5	5	13	M5xP0.8	5.5	
00-99805-M06-12A06	M06-12A06	12	2	4.0	5	13	M6xP1.0	6.5	
00-99805-M06-13A06	M06-13A06	13	2	3.5	5	13	M6xP1.0	6.5	
00-99805-M08-14A06	M08-14A06	14	2	3.0	5	13	M8xP1.25	8.5	
00-99805-M08-15A06	M08-15A06	15	3	2.5	5	15	M8xP1.25	8.5	
00-99805-M08-16A06	M08-16A06	16	3	2.0	5	15	M8xP1.25	8.5	
00-99805-M08-17A06	M08-17A06	17	3	1.5	5	15	M8xP1.25	8.5	
00-99802-M08-16A10	M08-16A10	16	2	2.5	9	25	M8xP1.25	8.5	A9...1035...
00-99802-M10-20A10	M10-20A10	20	3	2.0	9	30	M10xP1.5	10.5	
00-99802-M12-25A10-3T	M12-25A10-3T	25	3	1.3	9	35	M12xP1.75	12.5	
00-99805-M12-25A10	M12-25A10	25	3	1.3	9	20	M12xP1.75	12.5	

* For Nine9 extension bar, see page 6-3.

A Series Shoulder Face Mills



Features:

- Submicron carbide inserts are fully ground for high precision output.
- Good cutting performance and cutting edge strength, which produce perfect 90° shoulders.

Insert

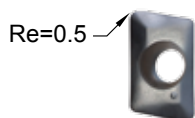

A9MT060205-NC5072

- High rigidity, special edge honing, resistance of impact during milling operation.
- Special chip breaker design for high removal rate.
- P40 tougher grade for smooth cutting, good for all kinds of steel.

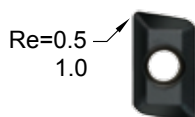

A9GT060205H-NC2033

- Sharp cutting edge and high positive rake angle, good for finishing milling and surface roughness.
- Re 0.5 and Re1.0 for your option.
- Suitable for all kinds of steel.

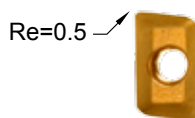

A9FT060205H-NC9031

- Sharp cutting edge and high positive rake angle, low friction coefficient for Non-Ferrous metal.
- Good for Al, Al-alloy, Copper, Copper alloy and Non-Ferrous metal.

Insert Size	Parts No.	Coating	Grade	Diagram	Dimensions					Screw / Key
					L	W	S	Re	Ap	
06	A9MT0602 05 -NC5072	TiAlN	P40		6.5	4	2.45	0.5	5	 *NS-18037 0.6Nm NK-T6
	A9GT0602 05H-NC2033	TiAlN	K20F		6.5	4	2.45	0.5	5	
	A9GT0602 10H-NC2033	TiAlN	K20F		6.5	4	2.45	1.0	5	
	A9FT0602 05H-NC9031	TiN	K20F		6.5	4	2.45	0.5	5	

*Torque screwdriver is recommended, see page 6-4.

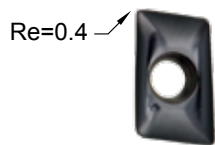

A9MT1035-NC2032

- High rigidity, special edge honing, resistance of impact during milling operation.
- Special chip breaker design for high removal rate.
- Good for hard cutting carbon steel and alloy steel.

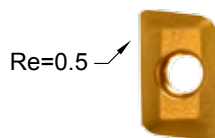

A9FT103505H-NC9031

- Sharp cutting edge and high positive rake angle, low friction coefficient for Non-Ferrous metal.
- Good for Al, Al-alloy, Copper, Copper alloy and Non-Ferrous metal.

Insert Size	Parts No.	Coating	Grade	Diagram	Dimensions					Screw / Key
					L	W	S	Re	Ap	
10	A9MT1035-NC2032	TiAlN	K20F		10	6.6	3.5	0.4	9	 *NS-25060 0.9Nm NK-T7
	A9FT103505H-NC9031	TiN	K20F		10	6.6	3.5	0.5	9	

*Torque screwdriver is recommended, see page 6-4.

A Series Shoulder Face Mills

Surface Roughness Comparison

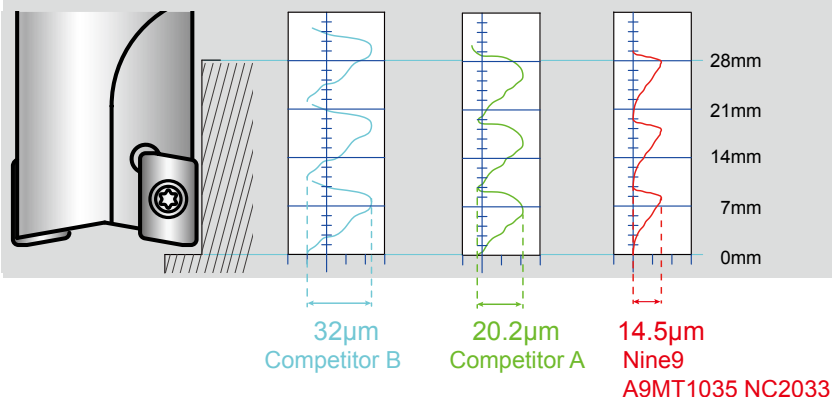

- Nine9 A series shoulder face mill insert receive a better result of surface finish.

Cutting Data

- Reduce the feed rate 30% from the below table for slotting operation.
- Ramping Angle should be Under α° .

► Insert Size: 6.5mm (Holder dia. Ø10~Ø17mm) : >>

Work Material	Sample Code (JIS)	Grade	Vc (m/min)	fz (mm/tooth)			Ae (mm)
Carbon Steel	P5	NC5072	80~150	0.03~0.07	1.5	4	1.5
		NC2033					
Low-alloy Steel, C ≤ 0.3%	SCM440	NC5072	80~150	0.03~0.07	1.5	4	1
		NC2033					
High-alloy Steel, C > 0.3%	SKD11	NC5072	60~120	0.03~0.07	1.0	2.5	1
		NC2033					
Stainless Steel	SUS304	NC5072	60~120	0.01~0.05	0.5	2	1
		NC2033					
Casting Iron	FC25	NC5072	60~120	0.03~0.07	1.0	2.5	1
		NC2033					
Malleable Cast Iron, Grey Cast Iron		NC5072	100~150	0.03~0.07	1.5	4	1.5
		NC2033					
Al, Al-alloy	A6061	NC9031	200~500	0.03~0.07	2	4	2

► Insert Size: 10mm (Holder Ø16~Ø25mm) : >>

Work Material	Sample Code (JIS)	Grade	Vc (m/min)	fz (mm/tooth)			Ae (mm)
Carbon Steel	P5	NC2032	150~250	0.08~0.15	3	8	3
Low-alloy Steel, C ≤ 0.3%	SCM440	NC2032	150~250	0.08~0.15	3	8	2
High-alloy Steel, C > 0.3%	SKD11	NC2032	120~200	0.08~0.15	2	4	2
Stainless Steel	SUS304	NC2032	80~120	0.04~0.08	1	4	2
Casting Iron	FC25	NC2032	120~200	0.08~0.12	2	5	2
Malleable Cast Iron, Grey Cast Iron		NC2032	100~150	0.06~0.10	3	8	3
Al, Al-alloy	A6061	NC9031	200~500	0.03~0.07	5	8	3

C Series Torus Radius Mills



Features:

- Good for corner finishing.
- Series C is developed for replacement of the other milling cutters with ram feed.

Holder

► Cylindrical Shank

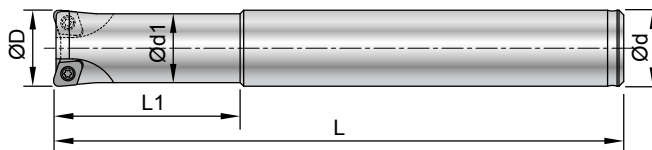
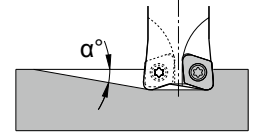

Part No.	Type	ØD	No. of teeth	Ød h6	Ød1	α°	L1	L	Insert type
00-99802-BC12-12C5	BC12-12C5	12	2	12	10.5	8.0	30	100	C9MT05T105 C9MT05T110H
00-99802-BC16-16C5	BC16-16C5	16	3	16	14.5	5.5	40	120	
00-99802-BC20-20C5	BC20-20C5	20	3	20	18	4.0	50	130	
00-99802-BC25-25C5	BC25-25C5	25	4	25	23	3.0	60	150	

► Screw-Fit Type

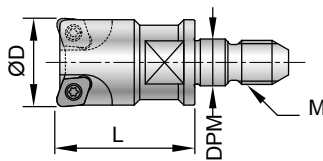

Part No.	Type	ØD	No. of teeth	α°	L	M	DPM	Insert type
00-99802-M05-10C4	M05-10C4	10	2	8	15	M5xP0.8	5.5	C9MT040105 C9MT040110
00-99802-M05-11C4	M05-11C4	11	2	6	15	M5xP0.8	5.5	
00-99802-M06-12C5	M06-12C5	12	2	8	25	M6xP1.0	6.5	C9MT05T105 C9MT05T110H
00-99802-M06-13C5	M06-13C5	13	2	7.5	25	M6xP1.0	6.5	
00-99802-M08-16C5	M08-16C5	16	3	5.5	25	M8xP1.25	8.5	
00-99802-M08-17C5	M08-17C5	17	3	5	25	M8xP1.25	8.5	
00-99802-M10-20C5	M10-20C5	20	3	4	30	M10xP1.5	10.5	
00-99802-M10-21C5	M10-21C5	21	3	3.5	30	M10xP1.5	10.5	
00-99802-M12-25C5	M12-25C5	25	4	3	35	M12xP1.75	12.5	
00-99802-M12-26C5	M12-26C5	26	4	2.5	35	M12xP1.75	12.5	
00-99805-M05-11C5	M05-11C5	11	2	10	13	M5xP0.8	5.5	C9MT05T105 C9MT05T110H
00-99805-M06-12C5	M06-12C5	12	2	8	13	M6xP1.0	6.5	
00-99805-M06-13C5	M06-13C5	13	2	7.5	13	M6xP1.0	6.5	
00-99805-M08-16C5	M08-16C5	16	3	5.5	15	M8xP1.25	8.5	
00-99805-M08-17C5	M08-17C5	17	3	5	15	M8xP1.25	8.5	
00-99805-M10-20C5	M10-20C5	20	3	4	15	M10xP1.5	10.5	
00-99805-M10-21C5	M10-21C5	21	3	3.5	15	M10xP1.5	10.5	
00-99805-M12-25C5	M12-25C5	25	4	3	20	M12xP1.75	12.5	
00-99805-M12-26C5	M12-26C5	26	4	2.5	20	M12xP1.75	12.5	

4

Power Mill

C Series Torus Radius Mills



Features:

- Submicron carbide inserts are fully ground.
- Special design milling cutter and ground insert for semi-finishing 3D surface milling for mold industry.

Insert

Re= 0.5
Re= 1.0



C9MT040105-NC30
C9MT040110-NC30
C9MT05T105-NC30

- Flat cutting edge design, universal type for all kind of materials.

Re= 0.5
Re= 1.0



C9MT05T110H-NC2032

- High positive angle, special chip breaker design, higher wearing resistance.
- Good for hardened material.

Dual Relief Angle Insert

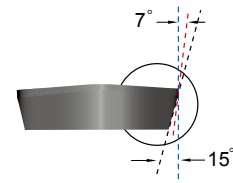

Higher feed rate!
Higher wearing resistance!

Parts No.	Coating	Grade		Dimensions			Screw	Key
				L	S	Re		
C9MT040105-NC30	AlTiN	K10F		4	1.59	0.5		
C9MT040110-NC30	AlTiN	K10F		4	1.59	1.0	*NS-18037 0.6Nm	NK-T6
C9MT05T105-NC30	AlTiN	K10F		5	2.0	0.5		
C9MT05T110H-NC2032	AlTiN	K20F		5	2.0	1.0	*NS-20045 0.6Nm	NK-T6

*Torque screwdriver is recommended, see page 6-4.

Cutting Data

Work Material	Sample Code (JIS)	Grade	Vc (m/min)	fz (mm/tooth)	Cutting Depth Ap(mm)
Carbon Steel	P5	NC30	150~300	0.2~0.5	0.2~0.5
		NC2032			
Alloy Steel	SCM440	NC30	120~250	0.2~0.5	0.2~0.5
		NC2032			
Stainless Steel	SUS304	NC30	120~200	0.2~0.4	0.2~0.4
		NC2032			
Hardened Steel < HRC52	SKD61	NC2032	100~150	0.1~0.3	0.1~0.3

* Recommend Ae below 2.5mm.

Round Insert Mills



Features:

- High feed rate capability.
- Corner radius, especially good for 3D corner milling, reliable tool life and high performance.

Holder

► Cylindrical Shank

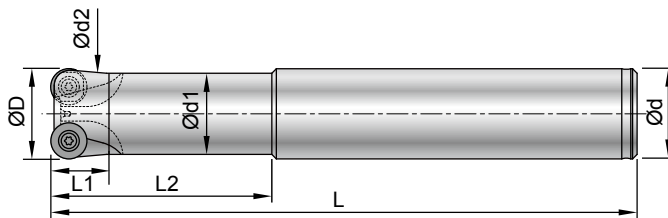
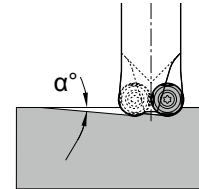

Part No.	Type	ØD	No. of teeth	Ød	Ød1	Ød2	α°	L1	L2	L	Insert type
00-99802-BC16-16R4	BC16-16R4-120	16	2	16	14.5	-	4.5	-	40	120	R9MT0803 R9MT0803F
00-99802-BC20-20R4	BC20-20R4-130	20	3	20	18	17	2.5	20	50	130	
00-99802-BC25-25R4-45°	BC25-25R4-150-45°	25	3	25	23	21	1.5	30	60	150	
00-99802-BC32-35R4	BC32-35R4-200	35	3	32	30	-	1.0	-	80	200	

The insert pocket of the cutter 25R4-45° has rotated 45°. The cutter can take advantage of the reverse side of the used insert for second use.

► Radius Cutter with Bore Type

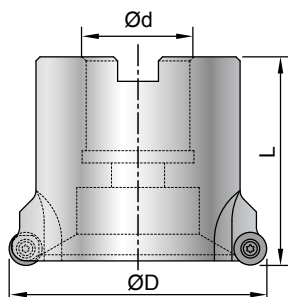

Part No.	Type	ØD	No. of teeth	Ød	L	Insert type
00-99802-MC22-50R4	MC22-50R4	50	4	22	51	R9MT0803 R9MT0803F
00-99802-MC25-63R4	MC25-63R4	63	5	25.4	51	
00-99802-MC25-80R4	MC25-80R4	80	5	25.4	51	
00-99802-MC31-100R4	MC31-100R4	100	6	31.75	61	

Round Insert Mills



Holder

► Screw Fit Type

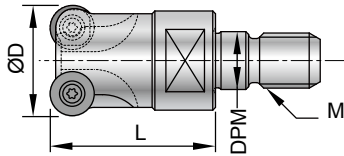
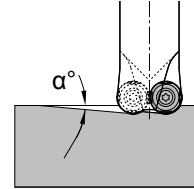

Part No.	Type	ØD	No. of teeth	α°	L	M	DPM	Insert type
00-99802-M08 -16R4	M08-16R4	16	2	4.5	25	M8 x P1.25	8.5	R9MT0803 R9MT0803F
00-99802-M08-17R4	M08-17R4	17	2	4.0	25	M8 x P1.25	8.5	
00-99802-M10-20R4	M10-20R4	20	3	2.5	30	M10 x P1.5	10.5	R9MT0803 R9MT0803F
00-99802-M10-21R4	M10-21R4	21	3	2.0	30	M10 x P1.5	10.5	
00-99802-M12-25R4-3T	M12-25R4-3T	25	3	1.5	35	M12 x P1.75	12.5	
00-99802-M12-26R4-3T	M12-26R4-3T	26	3	1.3	35	M12 x P1.75	12.5	
00-99802-M16-35R4	M16-35R4-4T	35	4	1.0	40	M16 x P2.0	16.5	

* For Nine9 extension bar, see page 6-3.

4

Power Mill

Round Insert Mills

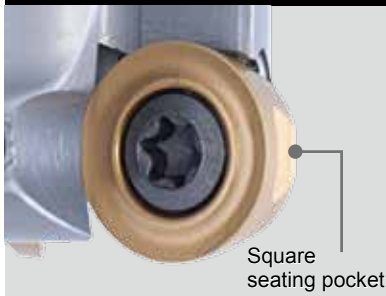

Square seating pocket

Features:

- Round insert with square seating pocket for exact positioning, especially for unstable cutting condition.
- Maximum number of teeth for feed operation.

Insert



R9MT0803F-NC2032

- Universal grade for all kinds of material.



R9MT0803-NC40

- Sharp cutting edge and high positive angle. Good for stainless steel.

Dual Relief Angle Insert

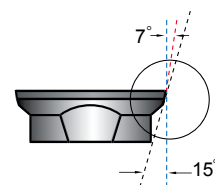

Higher feed rate!
Higher wearing resistance!

Part No.	Coating	Grade	Dimensions	Screw	Key
R9MT0803-NC40	TiN	K20F			
R9MT0803F-NC2032	AlTiN	K20F			

4

Power Mill

Cutting Data

Work Material	Sample Code (JIS)	Grade	Vc (m/min)	fz (mm/tooth)	Cutting Depth Ap(mm)
Carbon Steel	P5	NC2032	150~250	0.3~0.8	0.4~1.0
		NC2032	120~180	0.3~0.5	0.4~0.6
Alloy steel	SCM440	NC2032	120~180	0.3~0.6	0.4~0.6
		NC2032	100~150	0.2~0.4	0.3~0.6
Stainless Steel	SUS304	NC40	100~140	0.3~0.5	0.3~0.6
Hardened Steel < HRC52	SKD61	NC2032	60~120	0.2~0.4	0.3~0.4
Casting Iron	FC25	NC2032	120~180	0.3~0.8	0.4~0.6

$$S = \frac{Vc \times 1000}{\pi \times d} \text{ r.p.m}$$

$$F = fz \times S \times n \text{ mm/min.}$$

* S: Spindle Speed (r.p.m.) Vc: Cutting Speed (m/min.)

F: Feed Rate (mm/min.) fz: Feed per Tooth D: Drill Dia. n: No. of Flute

Extension Bar for A, C, R

► Steel Type

- T is the maximum overhang length.

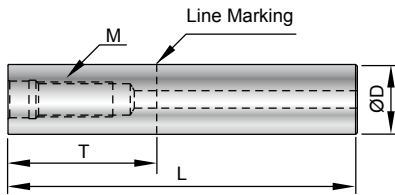

Part No.	Type	ØD	T	L	M	Assemble Torque
00-99801-10S	BC10-075M05S	10	25	75	M5xP0.8	6.5Nm
00-99801-12S	BC12-075M06S	12	25	75	M6xP1.0	11.0 Nm
00-99801-14S	BC14-090M08S	14	30	90	M8xP1.25	25.0 Nm
00-99801-16S	BC16-090M08S	16	35	90	M8xP1.25	25.0 Nm
00-99801-18S	BC18-100M10S	18	40	100	M10xP1.5	50.0 Nm
00-99801-20S	BC20-100M10S	20	40	100	M10xP1.5	50.0 Nm
00-99801-25S	BC25-120M12S	25	50	120	M12xP1.75	60.0 Nm
00-99801-32S	BC32-150M16S	32	65	150	M16xP2.0	-

► Solid Carbide Type

- T is the maximum overhang length.
- Carbide extension bar with longer tool length is available on request. (REVA brand)

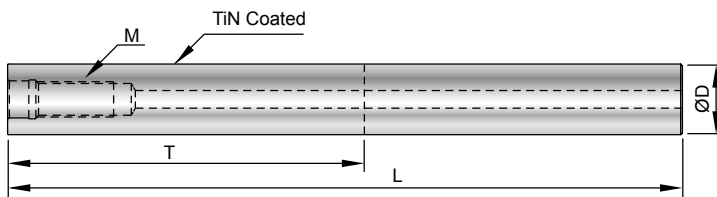

Part No.	Type	ØD	T	L	M	Assemble Torque
00-99801-10W	BC10-100M05W	10	50	100	M5xP0.8	6.5 Nm
00-99801-12W	BC12-100M06W	12	60	100	M6xP1.0	11.0 Nm
00-99801-14W	BC14-120M08W	14	70	120	M8xP1.25	25.0 Nm
00-99801-16W	BC16-150M08W	16	80	150	M8xP1.25	25.0 Nm
00-99801-18W	BC18-150M10W	18	90	150	M10xP1.5	50.0 Nm
00-99801-20W	BC20-200M10W	20	100	200	M10xP1.5	50.0 Nm
00-99801-25W	BC25-200M12W	25	125	200	M12xP1.75	60.0 Nm

* For more extension bar, please refer to P6-3.

Face milling cutter for steel



Features:

- Target M/C user.
- High power for metal removal.
- High feed Rate 0.5 mm/tooth.
- An economical 8 corners per side (16 corners in total)
3mm maximum depth of cut.

Cutter

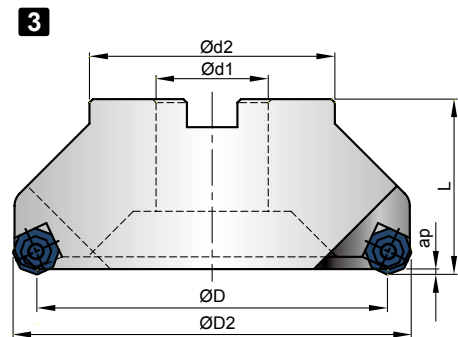
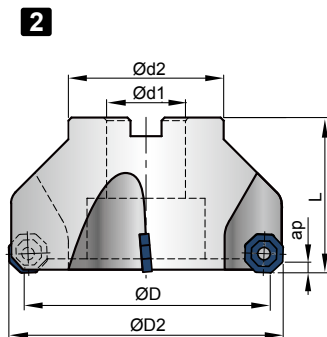
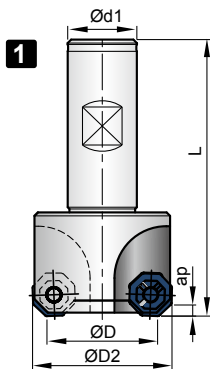

4

Power Mill

► Multi-edge rough milling cutter - Clockwise

Fig.	Part No.	Type	ØD	ØD2	No. of teeth	Ød1	Ød2	ap	L	Insert type
1	00-99542-032	SB20-32R-11J	32	40	3	20	-	3	80	N9GJ11T3F2-O
	00-99542-050	MC22-50R-11J	50	58	3	22	50	3	45	
	00-99542-063	MC22-63R-11J	63	71	4	22	50	3	45	
2	00-99542-080	MC25.4-80R-11J	80	88	5	25.4	50	3	50	
	00-99542-100	MC31.75-100R-11J	100	108	6	31.75	70	3	50	
	00-99542-125	MC38.1-125R-11J	125	133	6	38.1	85	3	63	
3	00-99543-063	MC22-63R-11J-6T	63	75	6	22	50	1.5	45.5	
	00-99543-080	MC27-80R-11J-8T	80	92	8	27	60	1.5	50.5	
	00-99543-100	MC32-100R-11J-10T	100	113	10	32	70	1.5	50	

► Multi-edge rough milling cutter - Counterclockwise

Fig.	Part No.	Type	ØD	ØD2	No. of teeth	Ød1	Ød2	ap	L	Insert type
2	00-99542-050L	MC22-50L-11J	50	58	3	22	50	3	45	N9GJ11T3F2-O
	00-99542-063L	MC22-63L-11J	63	71	4	22	50	3	45	
	00-99542-080L	MC25.4-80L-11J	80	88	5	25.4	50	3	50	
	00-99542-100L	MC31.75-100L-11J	100	108	6	31.75	70	3	50	
	00-99542-125L	MC38.1-125L-11J	125	133	6	38.1	85	3	63	

Face milling cutter for steel

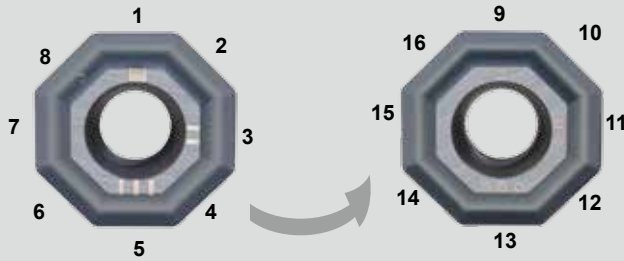

Features:

- Double-sided inserts for low costs.
- Easy to identify the sequence.



Insert

Double-sided

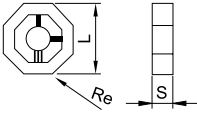

N9GJ11T3F2-O

- Good for carbon steel and alloy steel, stainless steel and cast iron.
- Each insert has 16 cutting edges.

Parts No.	Coating	Grade		Dimensions			Screw	Key
				L	S	Re		
N9GJ11T3F2-O-NC2032	AlTiN	K20F		12.2	3.97	0.8	 NS-35080 2.5Nm	 NK-T15

4

Power Mill

Cutting Data

Work Material	Sample Code (JIS)	Grade	Vc (m/min.)	fz (mm / tooth)
Carbon steel	P5	NC2032	120~250	0.1~0.5
Alloy steel	SCM440	NC2032	120~200	0.1~0.3
Stainless Steel	SUS304	NC2032	80~120	0.1~0.3
Casting iron	FC25	NC2032	100~200	0.1~0.5

Aluminum alloy face mill for aluminum

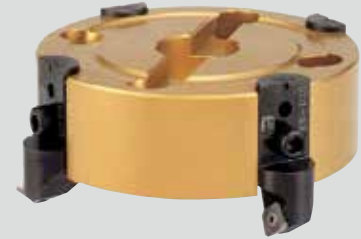
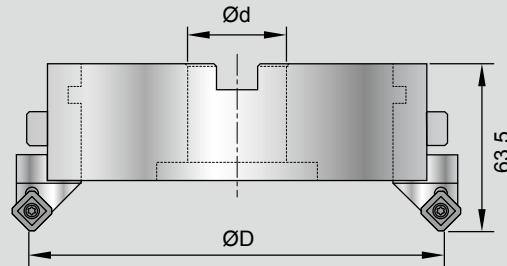
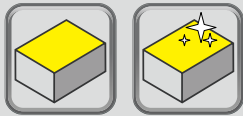

Cutter

► Milling cutter body

- Ideal for cutting aluminum alloy material.
- Aluminum alloy face milling cutter series provides the opportunity to assemble the body with different cartridges for a wide range of applications.
- Extra lightweight, only 1/3 to 1/2 the weight of steel body cutters.
(Weight of 160mm steel cutter is about 8.5kgs, 99511 is only 2.9kgs.)
- Suitable for machining centers, fine milling on big surface or when the weight of the cutter is restricted.

Part No.	Type	ØD	No. of teeth	Ød	Kg
00-99511-080	80S-AL	80	4	22	1.1
00-99511-100	100S-AL	100	4	22	1.4
00-99511-125	125S-AL	125	4	38.1	2.1
00-99511-160	160S-AL	160	4	38.1	2.9
00-99511-200	200S-AL	200	4	38.1	4.2
00-99511-250	250S-AL	250	4	38.1	6.5
00-99511-315	315S-AL	315	6	38.1	8.0

► Cartridges

Part No.	Type	Insert (Insert to be used)	ap	Screw	Key
00-99511-00A	SSFER-D25	SEHW1204	0.7	NS-45095	T15
00-99511-05A	STGCR-D25	TCGT16T3	0.5	NS-35080	
00-99511-10A	SSFER0°-D25	SEHW1204	0.5	NS-45095	
00-99511-20A	SAFPR-D25	APKT1604	0.7	NS-35080	
00-99511-39A	SNF9R-D25	N9MT11T3HR300	0.1	NS-35080	
00-99511-41A	SGFGR-D25	N9GJ11T3F2	0.3	NS-35080	

► Spare

Part No.		
	Cutter bodies	①
99511-00H	Screw sheath	②
MS1364	Eccentric adjustment screw	③
99511-00G	Seat Clamp Bolt	④
	Cartridges	⑤
99511-00I	M8 Set Screws	⑥
NK-DT25	Adjustment Wrench	
NK-T15	Key	

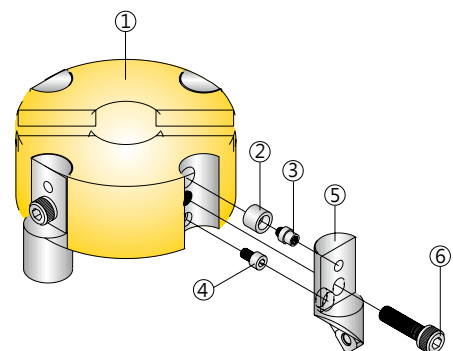

Aluminum alloy face mill for mirror finishing

Excellent Surface Finish



Cutting Data		Insert		N9MT11T3HR300 (Nine9)	SEHW1204 (Diamond insert)
VC	m/min.			1000	1000
fz	mm / tooth	0.10	0.20	0.10	
Ap	mm			0.05	0.10
Surface roughness (Ra) μm				0.056	0.092
				0.092	0.800

Insert

Double-sided



N9GJ11T3F2-NC2033

- Double-sided insert for low costs.
- Easy to identify the sequence.
- Each insert has 8 cutting edges.

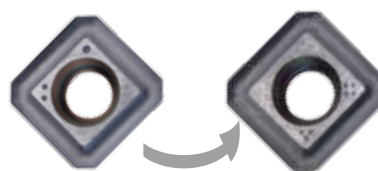

N9MT11T3HR300-NC9031

- For mirror finishing. Surface roughness below Ra 0.10 μm .
- Each insert has 2 cutting edges.

Parts No.	Coating	Grade	Re	Dimensions			Screw	Key
				L	S	Re		
N9GJ11T3F2-NC2033	TiAlN	K20F		10.9	3.97	0.6	NS-35080 2.5Nm	NK-T15
N9MT11T3HR300-NC9031	-	K20F		11.11	3.98	-	NS-35080 2.5Nm	NK-T15

Cutting Data

Work Material	Sample Code (JIS)	Grade	Vc (m/min.)	fz (mm / tooth)	Cutting Depth Ap(mm)
Non-ferrous metal (Al, Cu)	A6061	NC9031	200~500	0.1~0.3	0.05~0.15
		NC2033	200~500	0.05~0.15	0.1~0.5

4

Power Mill

-  Cycle Time
-  Roughness
-  Position Accuracy
-  True Roundness



EMB Boring Bars



Easy Adjustment / High Efficiency / Low Cost

EMB boring bars are “Eccentric Mechanism Boring bars” which can adjust to required diameter via an eccentrical mechanism. The boring bar is not at the center of the holder, but offset from the center.

EMB Boring Bar Family

- 00-99101:** 0.03 mm/div. adjustment range $\pm 0.5.$, $\varnothing 6.5\text{mm} \sim \varnothing 25.5\text{mm}$ boring bars.
- 00-99121:** 0.01 mm/div. adjustment range $\pm 0.1.$, $\varnothing 4.9\text{mm} \sim \varnothing 25.1\text{mm}$ boring bars.
- 00-99146:** 0.01 mm/div. adjustment range $\pm 0.12.$, G6.3, 10000 r.p.m.
 $\varnothing 4.87\text{mm} \sim \varnothing 50.12\text{mm}$ boring bars are interchangeable.
- 00-99151:** Deep hole boring 4 ~ 6XD.
 $\varnothing 4.87\text{mm} \sim \varnothing 20.12\text{mm}$ boring size.



Patent No:
108599(Taiwan),
ZL96201178.9(China)
I265836(Taiwan),
ZL200510101469.5(China),
US 7455487 B2(USA)



00-99101
00-99121



00-99146-BT30
00-99146-BT40
00-99146-BT50
00-99146-HSK63A
00-99146-CAT40



00-99146-01-32HB



00-99151A-xxxW

5

Boring Tool



Direct Adjusting Boring Bar



The Patented tool structure applies bit angle variation to produce slight size variation in diametric direction. Excellent for applications on single size boring tools, deep hole boring tools, special tools, etc. It features easy control of μ accuracy.

5

Boring Tool



Direct Adjusting Boring Bar Family

00-99043 screw fit boring head:
Adjustment range ± 0.1 ,
 $\varnothing 13.9\text{mm} \sim \varnothing 25.1\text{mm}$ boring head.

00-99801 extension bar:
Made by steel and solid carbide,
125mm maximum boring length.

00-99021 Direct adjusting boring bar
Adjustment range ± 0.1 ,
 $\varnothing 15.9\text{mm} \sim \varnothing 50.1\text{mm}$ boring head.

System

Quick Change High Speed EMB Boring Bars

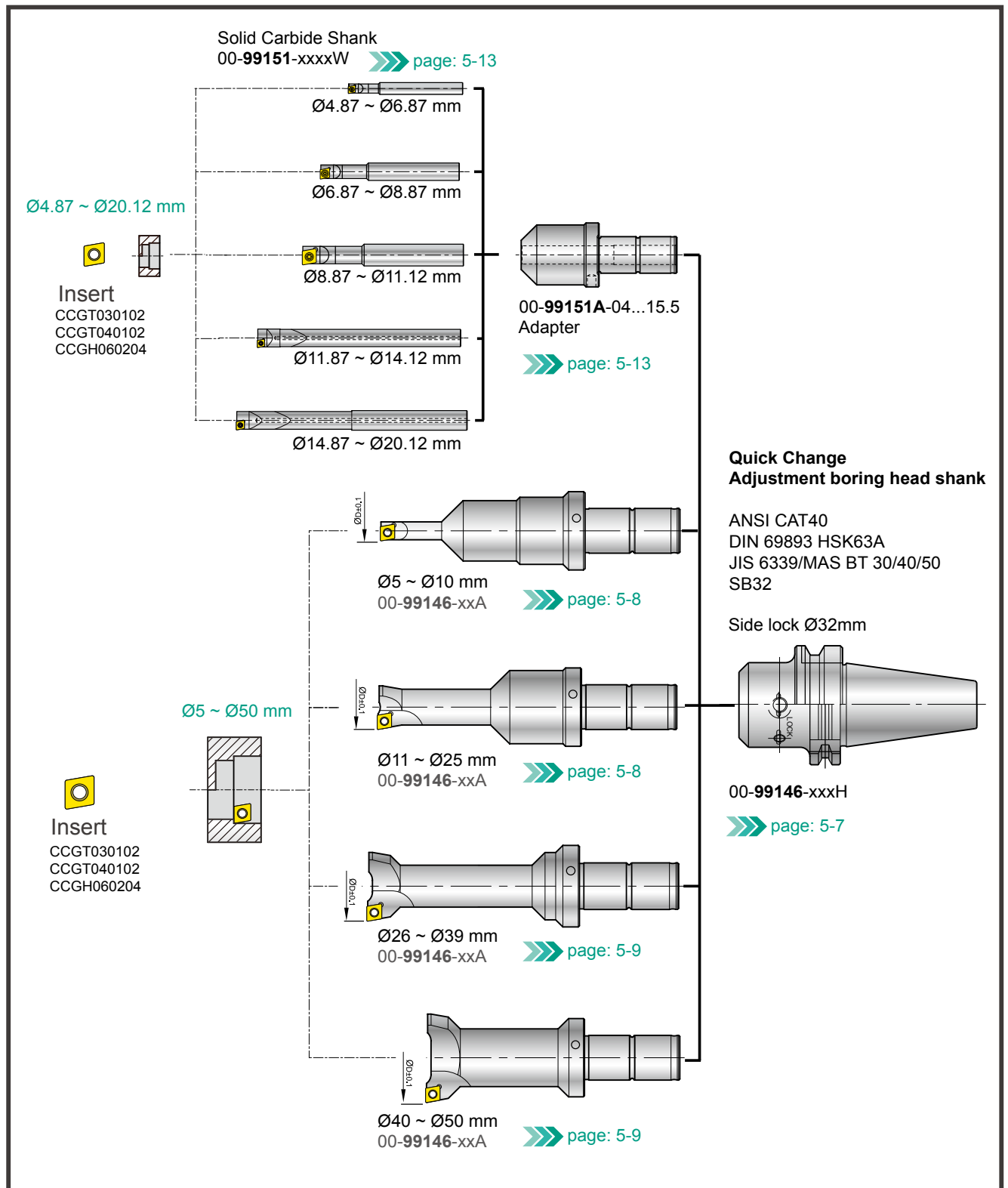

5

Boring Tool

System

99101 / 99121 EMB Boring Bars »»» page: 5-5

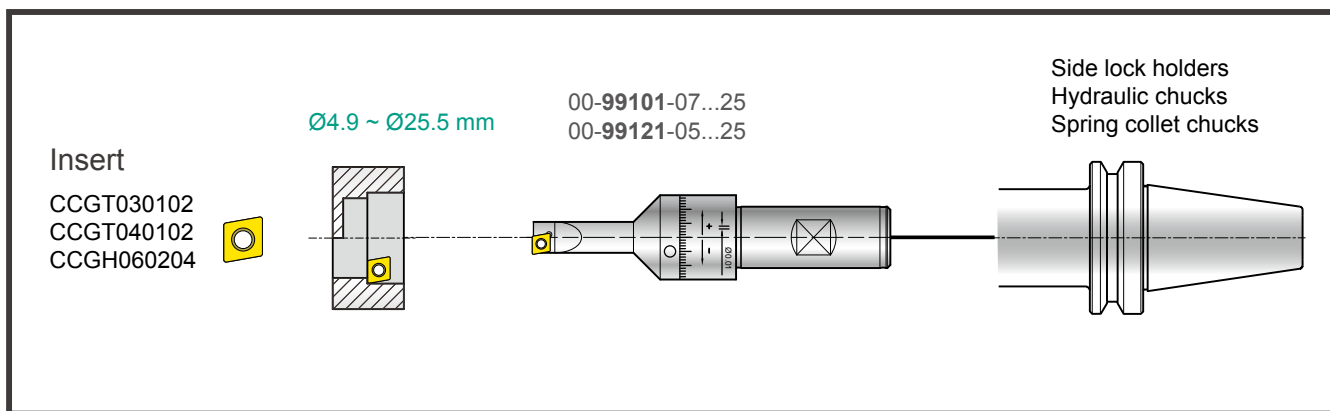

Direct Adjusting Boring Bar »»» page: 5-16

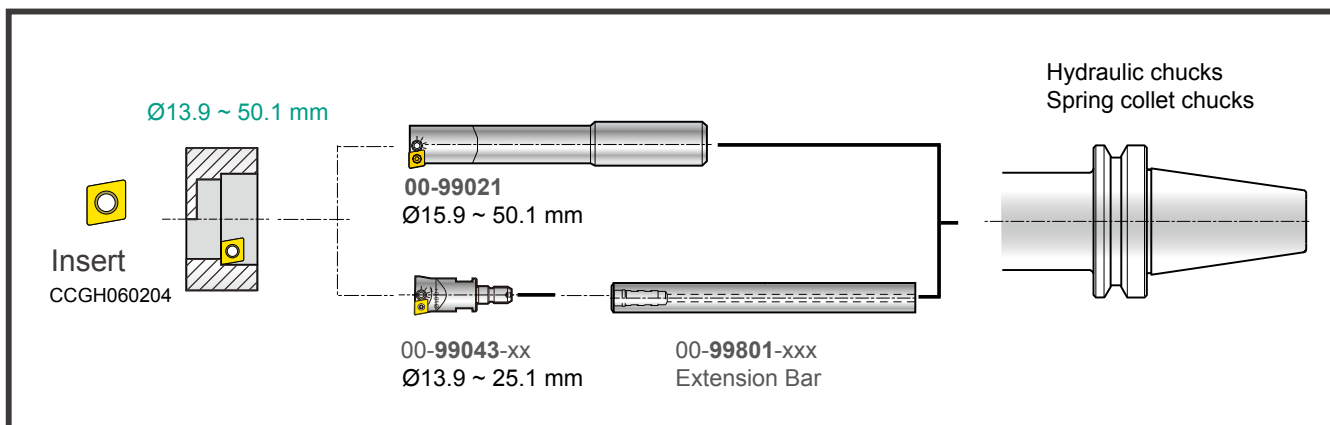

5

Boring Tool



99101 EMB Boring Bars 0.03 mm/div.



Diameter range:
6.5mm ~ 25.5mm

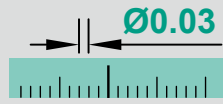

Each division 0.03mm shown on the tools, they are adjustable on the tool presetter or machine easily.

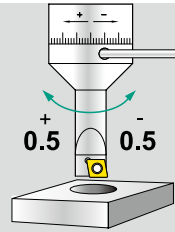

Total adjustment range ± 0.5 mm.



Adjusted to required diameter by eccentric mechanism, it is simple and backlash free.

Easy Handling

- Minimum readout division is 0.03 mm, it is easy for setting up fine boring.

Economic

- Low cost, high efficiency. It can replace end mill and brazed tool bits.
- The indexable insert allows a variety of materials to be cut .

Application

- Ideal as small hole boring tool with excellent accuracy.
- For fine boring operation on milling machines, machining centres and special purpose machines.

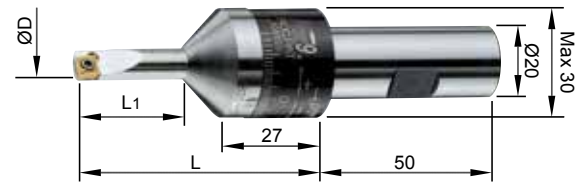

* H type with internal coolant can be ordered on request from Dia. 7mm. Ordering example: 00-99101-07H.

* Other sizes are available on request.

5

Boring Tool

Part No.	Type		ØD	L1	L	Insert	Screw / Key
00-99101-07	SB20-0721-03	Adjustment range: ± 0.5 mm Each Division 0.03mm	6.5-7.5	21	60	CC...040102	*NS-20036 0.6Nm / NK-T6
00-99101-08	SB20-0824-03		7.5-8.5	24	63		
00-99101-09	SB20-0927-03		8.5-9.5	27	65		
00-99101-10	SB20-1030-03		9.5-10.5	30	68	CC...0602...	*NS-25045 0.9Nm / NK-T7
00-99101-11	SB20-1133-03		10.5-11.5	33	70		
00-99101-12	SB20-1236-03		11.5-12.5	36	73		
00-99101-13	SB20-1339-03		12.5-13.5	39	75		
00-99101-14	SB20-1442-03		13.5-14.5	42	78		
00-99101-15	SB20-1545-03		14.5-15.5	45	80		
00-99101-16	SB20-1648-03		15.5-16.5	48	83	CC...0602...	*NS-25060 0.9Nm / NK-T7
00-99101-17	SB20-1751-03		16.5-17.5	51	85		
00-99101-18	SB20-1850-03		17.5-18.5	50	82		
00-99101-19	SB20-1950-03		18.5-19.5	50	82		
00-99101-20	SB20-2050-03		19.5-20.5	50	82		
00-99101-21	SB20-2150-03		20.5-21.5	50	82		
00-99101-22	SB20-2250-03	21.5-22.5	50	82			
00-99101-23	SB20-2350-03	22.5-23.5	50	82			
00-99101-24	SB20-2450-03	23.5-24.5	50	82			
00-99101-25	SB20-2550-03	24.5-25.5	50	82			

99121 EMB Boring Bars 0.01 mm/div.



Diameter range:
4.9mm ~ 25.1mm

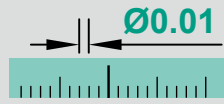

Each division 0.01mm shown on the tools, they are adjustable on the tool presetter or machine easily.

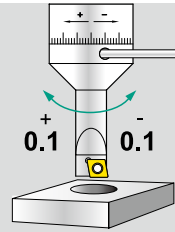

Total adjustment range ± 0.1 mm.

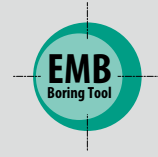

Adjusted to required diameter by eccentric mechanism, it is simple and backlash free.

Easy Handling

- Minimum readout division is 0.01 mm, it is easy for setting up fine boring.

Economic

- Low cost, high efficiency. It can replace end mill and brazed tool bits.
- The indexable insert allows a variety of materials to be cut .

Application

- Ideal as small hole boring tool with excellent accuracy.
- For fine boring operation on milling machines, machining centres and special purpose machines.

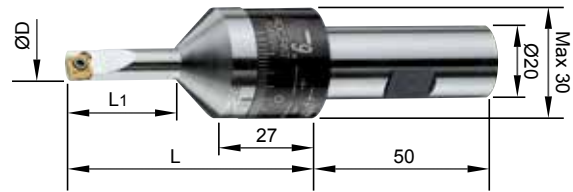

* H type with internal coolant can be ordered on request from Dia. 7mm. Ordering example: 00-99121-07H.

* Other sizes are available on request.

Part No.	Type		ØD	L1	L	Insert	Screw / Key
00-99121-05	SB20-0515-01	Adjustment range: ± 0.1 mm Each Division 0.01mm	4.9-5.1	15	54	CC...030102	*NS-16030 0.4Nm / NK-T6
00-99121-06	SB20-0618-01		5.9-6.1	18	57		
00-99121-07	SB20-0721-01		6.9-7.1	21	60		
00-99121-08	SB20-0824-01		7.9-8.1	24	63	CC...040102	*NS-20036 0.6Nm / NK-T6
00-99121-09	SB20-0927-01		8.9-9.1	27	65		
00-99121-10	SB20-1030-01		9.9-10.1	30	68		
00-99121-11	SB20-1133-01		10.9-11.1	33	70	CC...0602...	*NS-25045 0.9Nm / NK-T7
00-99121-12	SB20-1236-01		11.9-12.1	36	73		
00-99121-13	SB20-1339-01		12.9-13.1	39	75		
00-99121-14	SB20-1442-01		13.9-14.1	42	78		
00-99121-15	SB20-1545-01		14.9-15.1	45	80		
00-99121-16	SB20-1648-01		15.9-16.1	48	83	CC...0602...	*NS-25060 0.9Nm / NK-T7
00-99121-17	SB20-1751-01		16.9-17.1	51	85		
00-99121-18	SB20-1850-01		17.9-18.1	50	82		
00-99121-19	SB20-1950-01		18.9-19.1	50	82		
00-99121-20	SB20-2050-01		19.9-20.1	50	82		
00-99121-21	SB20-2150-01		20.9-21.1	50	82		
00-99121-22	SB20-2250-01		21.9-22.1	50	82		
00-99121-23	SB20-2350-01		22.9-23.1	50	82		
00-99121-24	SB20-2450-01		23.9-24.1	50	82		
00-99121-25	SB20-2550-01		24.9-25.1	50	82		

*Torque screwdriver is recommended, see page 6-4.

5

Boring Tool

Quick Change High Speed EMB Boring Bar



Diameter range:
4.87mm ~ 50.12mm

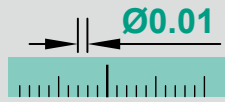

Each division 0.01mm shown on the tools, they are adjustable on the tool presetter or machine easily.



Adjustment range:
+0.12 / -0.13mm.



Balance grade:
G6.3 10000 r.p.m

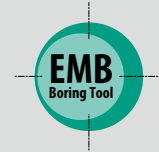

Adjusted to required diameter by eccentric mechanism, it is simple and backlash free.

Easy Handling

- Dimensions are easy to read. They are indicated on the tools and are easily adjusted on a tool presetter or in machining center.
- No backlash.

Interchangeable Boring Bars from Diameters of 5 mm to 50 mm

- This simple boring tool has minimal components. In minutes, the boring bar may be changed and the boring dimension set on the tool presetter.

Low Cost For Machining Small Holes

- Low cost micro adjustable boring heads.

High Speed

- Boring bar design ensures accurate high speed boring. Grade balance is G6.3 10000 r.p.m., all sizes are guaranteed.
- Surface speeds of carbide inserts up to 700 m/min.
- Combination bore / chamfer / facing tools can be ordered on request.

5

Boring Head Shank

Boring Tool

• HSK63

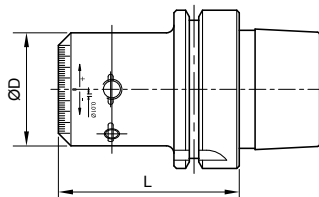

• CAT40

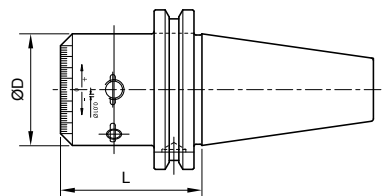

• BT

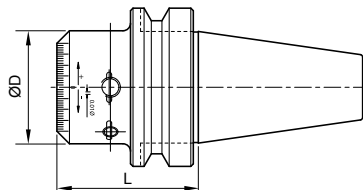

• SB32

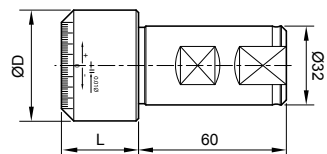

Part No.	Type	ØD	L
00-99146-HSK63AH	HSK63A-146-72	45	72
00-99146-CAT40H	CAT40-146-56	45	56.3
00-99146-BT30H	BT30-146-51	45	51.3
00-99146-BT40H	BT40-146-56	45	56.3
00-99146-BT50H	BT50-146-77	45	77.3
00-99146-SB32H	SB32-146-31	45	31.3

Quick Change High Speed EMB Boring Bar

Boring Bar Ø5~Ø25

- Alloy Steel Shank
- Boring Depth : L1, 2~3xD

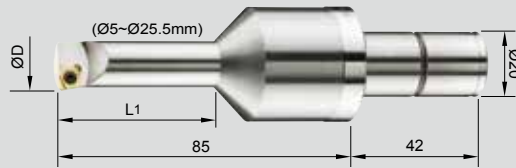

* H type with internal coolant can be ordered on request from Dia. 10mm.

Ordering example: 00-99146-1000SH.

* Other sizes are available on request.

Part No.	Type	ØD	L1	Insert	Part No.	Type	ØD	L1	Insert
00-99146-0500S	C20-0500-10L	4.87~5.12	10.00	CC...030102 *NS-16030	00-99146-1725S	C20-1725-42L	17.12~17.37	42.50	CC...0602... Screw: *NS-25045 0.9Nm Key: NK-T7
00-99146-0600S	C20-0600-12L	5.87~6.12	12.00	0.4Nm / NK-T6	00-99146-1750S	C20-1750-43L	17.37~17.62	43.75	
00-99146-0700S	C20-0700-14L	6.87~7.12	14.00	CC...040102 *NS-20036,	00-99146-1775S	C20-1775-43L	17.62~17.87	43.75	
00-99146-0800S	C20-0800-16L	7.87~8.12	16.00	0.6Nm / NK-T6	00-99146-1800S	C20-1800-45L	17.87~18.12	45.00	
00-99146-0900S	C20-0900-18L	8.87~9.12	18.00		00-99146-1825S	C20-1825-45L	18.12~18.37	45.00	
00-99146-1000S	C20-1000-25L	9.87~10.12	25.00		00-99146-1850S	C20-1850-46L	18.37~18.62	46.25	
00-99146-1025S	C20-1025-25L	10.12~10.37	25.00		00-99146-1875S	C20-1875-46L	18.62~18.87	46.25	
00-99146-1050S	C20-1050-26L	10.37~10.62	26.25		00-99146-1900S	C20-1900-47L	18.87~19.12	47.50	
00-99146-1075S	C20-1075-26L	10.62~10.87	26.25		00-99146-1925S	C20-1925-47L	19.12~19.37	47.50	
00-99146-1100S	C20-1100-27L	10.87~11.12	27.50		00-99146-1950S	C20-1950-48L	19.37~19.62	48.75	
00-99146-1125S	C20-1125-27L	11.12~11.37	27.50		00-99146-1975S	C20-1975-48L	19.62~19.87	48.75	
00-99146-1150S	C20-1150-28L	11.37~11.62	28.75		00-99146-2000S	C20-2000-50L	19.87~20.12	50.00	
00-99146-1175S	C20-1175-28L	11.62~11.87	28.75		00-99146-2025S	C20-2025-50L	20.12~20.37	50.00	
00-99146-1200S	C20-1200-30L	11.87~12.12	30.00		00-99146-2050S	C20-2050-50L	20.37~20.62	50.00	
00-99146-1225S	C20-1225-30L	12.12~12.37	30.00		00-99146-2075S	C20-2075-50L	20.62~20.87	50.00	
00-99146-1250S	C20-1250-31L	12.37~12.62	31.25		00-99146-2100S	C20-2100-50L	20.87~21.12	50.00	
00-99146-1275S	C20-1275-31L	12.62~12.87	31.25		00-99146-2125S	C20-2125-50L	21.12~21.37	50.00	
00-99146-1300S	C20-1300-32L	12.87~13.12	32.50		00-99146-2150S	C20-2150-50L	21.37~21.62	50.00	
00-99146-1325S	C20-1325-32L	13.12~13.37	32.50		00-99146-2175S	C20-2175-50L	21.62~21.87	50.00	
00-99146-1350S	C20-1350-33L	13.37~13.62	33.75		00-99146-2200S	C20-2200-50L	21.87~22.12	50.00	
00-99146-1375S	C20-1375-33L	13.62~13.87	33.75		00-99146-2225S	C20-2225-50L	22.12~22.37	50.00	
00-99146-1400S	C20-1400-35L	13.87~14.12	35.00		00-99146-2250S	C20-2250-50L	22.37~22.62	50.00	
00-99146-1425S	C20-1425-35L	14.12~14.37	35.00		00-99146-2275S	C20-2275-50L	22.62~22.87	50.00	
00-99146-1450S	C20-1450-36L	14.37~14.62	36.25		00-99146-2300S	C20-2300-50L	22.87~23.12	50.00	
00-99146-1475S	C20-1475-36L	14.62~14.87	36.25		00-99146-2325S	C20-2325-50L	23.12~23.37	50.00	
00-99146-1500S	C20-1500-37L	14.87~15.12	37.50		00-99146-2350S	C20-2350-50L	23.37~23.62	50.00	
00-99146-1525S	C20-1525-37L	15.12~15.37	37.50		00-99146-2375S	C20-2375-50L	23.62~23.87	50.00	
00-99146-1550S	C20-1550-38L	15.37~15.62	38.75		00-99146-2400S	C20-2400-50L	23.87~24.12	50.00	
00-99146-1575S	C20-1575-38L	15.62~15.87	38.75		00-99146-2425S	C20-2425-50L	24.12~24.37	50.00	
00-99146-1600S	C20-1600-40L	15.87~16.12	40.00		00-99146-2450S	C20-2450-50L	24.37~24.62	50.00	
00-99146-1625S	C20-1625-40L	16.12~16.37	40.00		00-99146-2475S	C20-2475-50L	24.62~24.87	50.00	
00-99146-1650S	C20-1650-41L	16.37~16.62	41.25		00-99146-2500S	C20-2500-50L	24.87~25.12	50.00	
00-99146-1675S	C20-1675-41L	16.62~16.87	41.25		00-99146-2525S	C20-2525-50L	25.12~25.37	50.00	
00-99146-1700S	C20-1700-42L	16.87~17.12	42.50		00-99146-2550S	C20-2550-50L	25.37~25.62	50.00	

*Torque screwdriver is recommended, see page 6-4.

Quick Change High Speed EMB Boring Bar

Boring Bar Ø26~Ø50

- Alloy Steel Shank
- Boring Depth : L1, 2~3xD

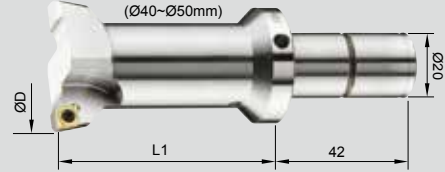
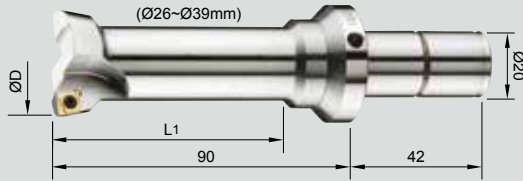

Ø26~Ø39mm

* H type with internal coolant can be ordered on request.
Ordering example: 00-99146-36AH.

Ø40~Ø50mm

* H type with internal coolant can be ordered on request.
Ordering example: 00-99146-45AH.

Part No.	Type	ØD	L1	Insert
00-99146-26A	C20-2600-50L	25.87~26.12	50.00	CC...0602... Screw: *NS-25060 0.9Nm Key: NK-T7
00-99146-27A	C20-2700-50L	26.87~27.12	50.00	
00-99146-28A	C20-2800-50L	27.87~28.12	50.00	
00-99146-29A	C20-2900-50L	28.87~29.12	50.00	
00-99146-30A	C20-3000-50L	29.87~30.12	50.00	
00-99146-31A	C20-3100-70L	30.87~31.12	70.00	
00-99146-32A	C20-3200-70L	31.87~32.12	70.00	
00-99146-33A	C20-3300-70L	32.87~33.12	70.00	
00-99146-34A	C20-3400-70L	33.87~34.12	70.00	
00-99146-35A	C20-3500-70L	34.87~35.12	70.00	
00-99146-36A	C20-3600-70L	35.87~36.12	70.00	
00-99146-37A	C20-3700-70L	36.87~37.12	70.00	
00-99146-38A	C20-3800-70L	37.87~38.12	70.00	
00-99146-39A	C20-3900-70L	38.87~39.12	70.00	

Part No.	Type	ØD	L1	Insert
00-99146-40A	C20-4000-70L	39.87~40.12	70.00	CC...0602... Screw: *NS-25060 0.9Nm Key: NK-T7
00-99146-41A	C20-4100-70L	40.87~41.12	70.00	
00-99146-42A	C20-4200-70L	41.87~42.12	70.00	
00-99146-43A	C20-4300-70L	42.87~43.12	70.00	
00-99146-44A	C20-4400-70L	43.87~44.12	70.00	
00-99146-45A	C20-4500-70L	44.87~45.12	70.00	
00-99146-46A	C20-4600-70L	45.87~46.12	70.00	
00-99146-47A	C20-4700-70L	46.87~47.12	70.00	
00-99146-48A	C20-4800-70L	47.87~48.12	70.00	
00-99146-49A	C20-4900-70L	48.87~49.12	70.00	
00-99146-50A	C20-5000-70L	49.87~50.12	70.00	

*Torque screwdriver is recommended, see page 6-4.

5

Boring Tool

High Speed Boring Bar Kit

Part No.	Contents
00-99146-SB32H-05SET	SB32-146-31 Weldon Shank
00-99146-BT30-05SET	BT30H Boring head shank
00-99146-BT40-05SET	BT40H Boring head shank
00-99146-BT50-05SET	BT50H Boring head shank
00-99146-CAT40-05SET	CAT40H Boring head shank
00-99146-SK40-05SET	SK40H Boring head shank
00-99146-HSK63A-05SET	HSK63A Boring head shank

Boring head shank: 1pc
Boring bar: any 5 pcs from Ø5~Ø50
Key: 3~5 pcs
Plastic box: 1pc



(Insert is not included, please order separately)
• Note: BT50 boring head shank is packed in a separate box.

Application Example

Machining a cover of scooter engine:

Workpiece material:
Die casting, Al-alloy, ADC-12(A383)
Spindle Size: BT40

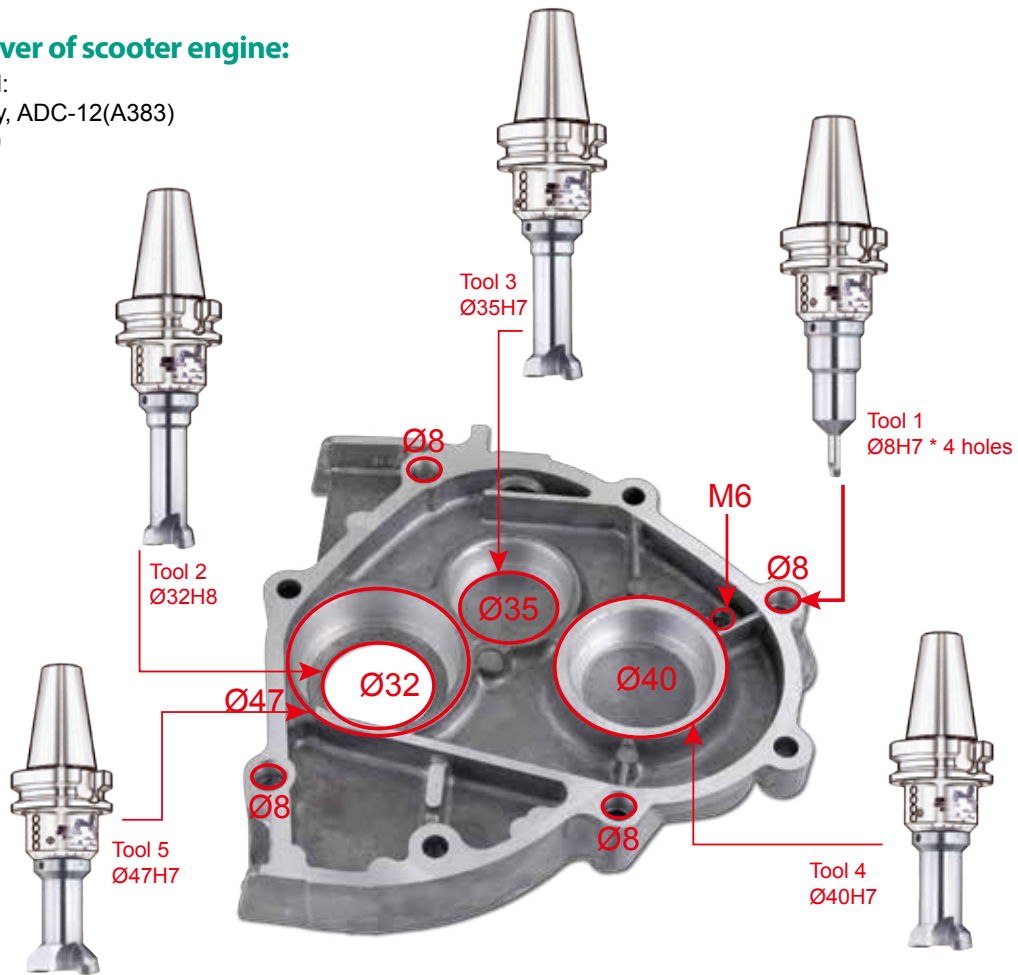

TOOL LIST by Nine9 Boring Bar 99146-series :

No.	Boring Bar	Grade of insert	Dia. mm	Depth	r.p.m.	F = mm/min.	Machining time
1	00-99146-08A	CCGT040102 NC30	Ø8H7	8 mm	8000	400	1.2 sec.
2	00-99146-32A	CCGT060202HP NC9031	Ø32H8	8 mm	2985	209	2.3 sec.
3	00-99146-35A		Ø35H7	12 mm	2730	191	3.8 sec.
4	00-99146-40A		Ø40H7	15 mm	2400	168	5.4 sec.
5	00-99146-47A		Ø47H7	15 mm	2030	142	6.4 sec.

5

Boring Tool

Working Example

	Material	Vc m/min.	f mm/rev.	Roughness			Tool holder	Insert
				Ra	Rz	Rmax		
	Al alloy, 6061	150	0.2	0.076µm	0.50µm	0.6µm	99146-BT40-26A	CCGH0602U NC9036

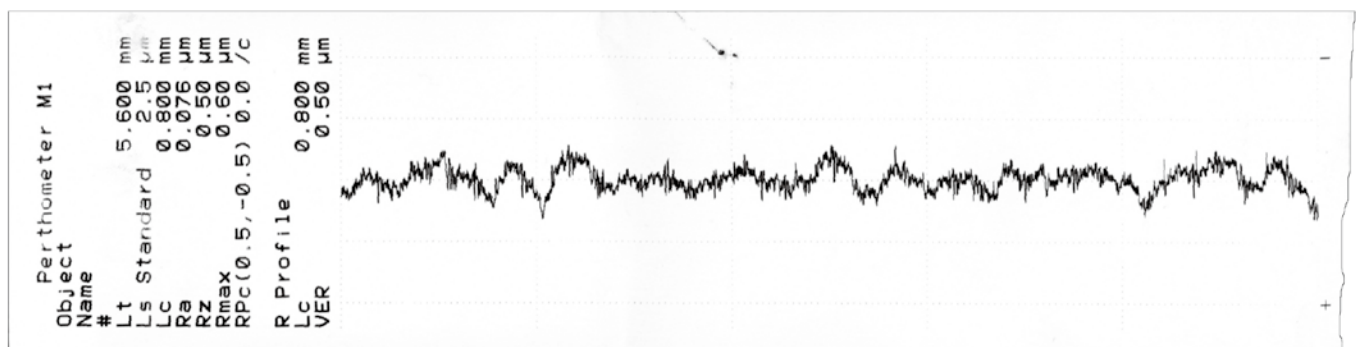

Quick Change High Speed EMB Boring Bar - Procedures For Assembly

1. Use 4 mm allen-key to **loosen locking screw M8**, take care not to remove the screw.
2. Use 3 mm allen-key to **loosen pre-load screw M6**, take care not to remove the screw.
3. Remove the original boring bar and insert the new boring bar.
4. **Tighten the M6 pre-load screw**. Recommended torque = 0.9 ~ 1.0Nm.
5. Measure the boring diameter of the boring bar using tool presetter and adjust it to the required diameter.
6. **Tighten the M8 locking screw**. Recommended torque = 8 ~ 9Nm.

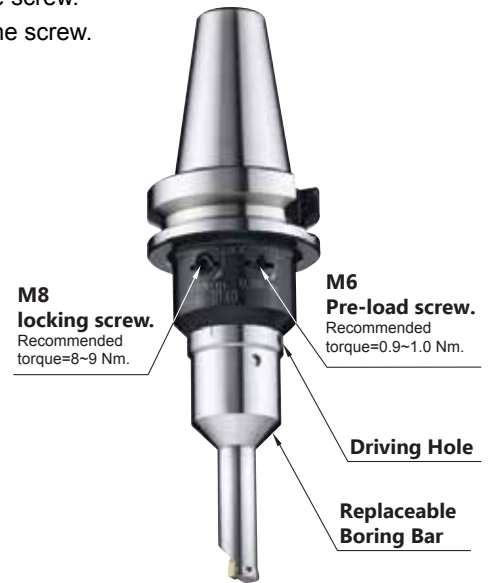
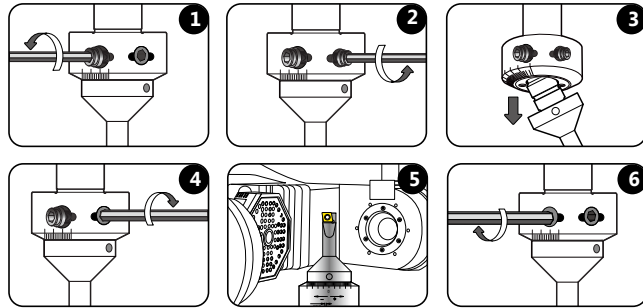

- Procedures For Adjustment

On Tool Presetter

1. Loosen M8 locking screw.
2. Set the boring bar at the neutral position. (Step 1)
3. Measure the boring diameter using the tool presetter and compare with the required diameter. (Step 2)
4. If boring diameter is too big or too small, please put an allen-key into the adjusting driving hole. Turn to “ + ” to increase and turn to “ - ” to reduce boring diameter. (Step 3 and 4)
5. Tighten M8 locking screw.

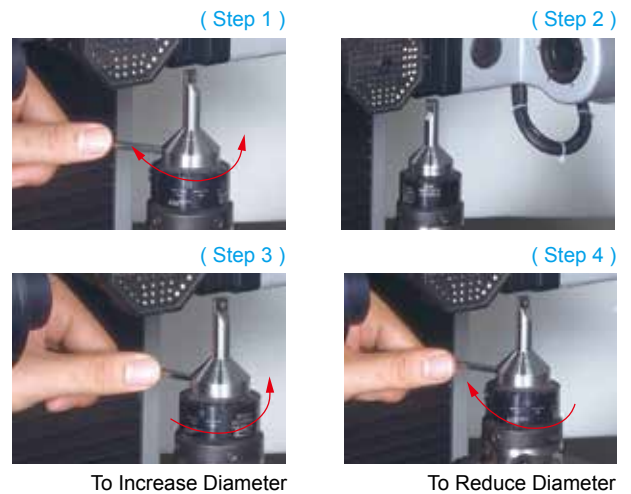

On Milling Machine and Machining Centers

1. Set the boring bar at the neutral position. (Step 1)
2. Tighten M8 locking screw.
3. Test cut on work piece, about 3-5mm depth on the machine.
4. Measuring boring diameter of workpiece and compare with required diameter.
5. If boring diameter is too big or too small, loosen M8 locking screw, please put an allen-key into the adjusting driving hole. Turn to “ + ” to increase and turn to “ - ” to reduce boring diameter. (Step 2 and 3)
6. Tighten M8 locking screw. (Step 4)

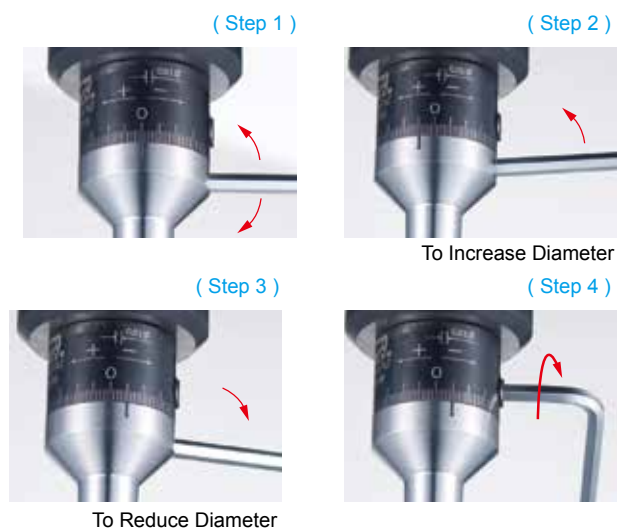

99151 Deep hole boring 4~6XD

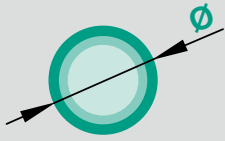

Diameter range:
4.87mm ~ 20.12mm

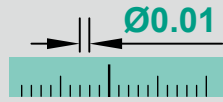

Each division 0.01mm shown
on the tools, they are adjustable
on the tool presetter or machine
easily.



Adjustment range:
+0.1 / -0.1mm.

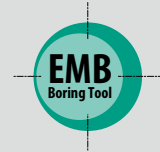

Adjusted to required diameter
by eccentric mechanism, it is
simple and backlash free.

Easy Handling

- 4~6xD boring depth, Good balance condition is maintained .

Economic

- Low cost, high efficiency. It can replace end mill and brazed tool bits.
- The indexable insert allows a variety of materials to be cut .

Application

- Replace end mill or reamer in small hole boring.
- Apply for electronic parts and micro machining parts.

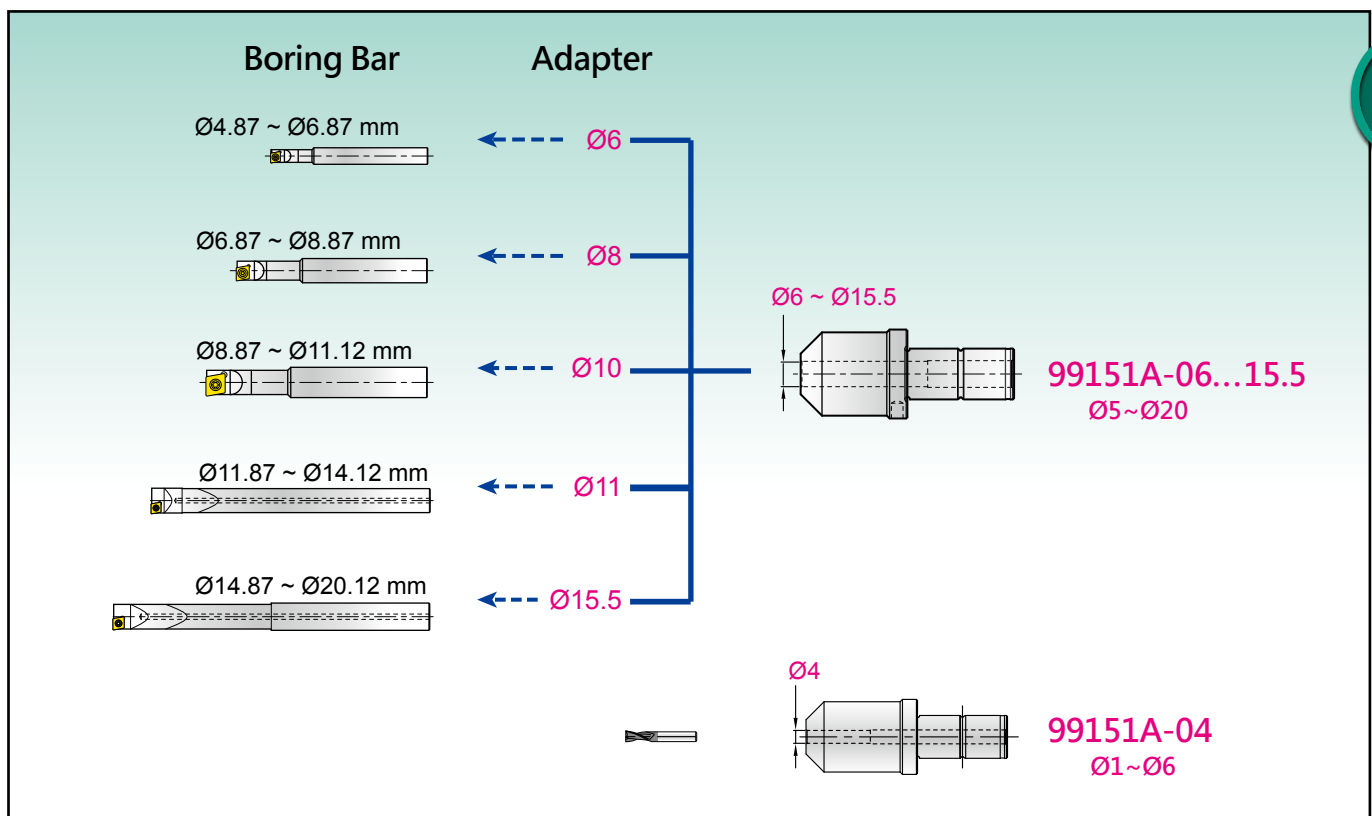

5

Boring Tool

99151 Deep hole boring 4~6XD

Adapter

- Economical solution of small dia. boring bar.



Part No.	Type	ØD	L
00-99151A-04	C20-ID04	4	49
00-99151A-06	C20-ID06	6	52
00-99151A-08	C20-ID08	8	49
00-99151A-10	C20-ID10	10	42
00-99151A-11	C20-ID11	11	21.5
00-99151A-15.5	C20-ID15.5	15.5	21.5

Boring Bar Ø5~Ø20

- Solid Carbide Shank
- Boring Depth : L1, 4~6xD





Part No.	Type	ØD	Ød	Ød1	L1	L	Insert	Fig.
00-99151-0500W	C06-0500-20L	4.87~5.12	6	-	20.00	70	CCGT030102 Screw: *NS-16030 / 0.4Nm Key:NK-T6	
00-99151-0525W	C06-0525-20L	5.12~5.37	6	-	20.00	70		
00-99151-0550W	C06-0550-22L	5.37~5.62	6	-	22.00	70		
00-99151-0575W	C06-0575-22L	5.62~5.87	6	-	22.00	70		
00-99151-0600W	C06-0600-24L	5.87~6.12	6	-	24.00	70		
00-99151-0625W	C06-0625-24L	6.12~6.37	6	-	24.00	70		
00-99151-0650W	C06-0650-26L	6.37~6.62	6	-	26.00	70		
00-99151-0675W	C06-0675-26L	6.62~6.87	6	-	26.00	70		
00-99151-0700W	C08-0700-28L	6.87~7.12	8	-	28.00	85	CCGT040102 Screw: *NS-20036 / 0.6Nm Key:NK-T6	
00-99151-0725W	C08-0725-28L	7.12~7.37	8	-	28.00	85		
00-99151-0750W	C08-0750-30L	7.37~7.62	8	-	30.00	85		
00-99151-0775W	C08-0775-30L	7.62~7.87	8	-	30.00	85		
00-99151-0800W	C08-0800-32L	7.87~8.12	8	-	32.00	85		
00-99151-0825W	C08-0825-32L	8.12~8.37	8	-	32.00	85		
00-99151-0850W	C08-0850-34L	8.37~8.62	8	-	34.00	85		
00-99151-0875W	C08-0875-34L	8.62~8.87	8	-	34.00	85		
00-99151-0900W	C10-0900-36L	8.87~9.12	10	-	36.00	110	CC...0602... Screw: *NS-25045 / 0.9Nm Key:NK-T7	
00-99151-0925W	C10-0925-36L	9.12~9.37	10	-	36.00	110		
00-99151-0950W	C10-0950-38L	9.37~9.62	10	-	38.00	110		
00-99151-0975W	C10-0975-38L	9.62~9.87	10	-	38.00	110		
00-99151-1000W	C10-1000-40L	9.87~10.12	10	-	40.00	110		
00-99151-1025W	C10-1025-40L	10.12~10.37	10	-	40.00	110		
00-99151-1050W	C10-1050-42L	10.37~10.62	10	-	42.00	110		
00-99151-1075W	C10-1075-42L	10.62~10.87	10	-	42.00	110		
00-99151-1100W	C10-1100-44L	10.87~11.12	10	-	44.00	110		
00-99151-1200W	C11-1200-150L	11.87~12.12	11	11	70.00	150	CC...0602... Screw: *NS-25045 / 0.9Nm Key:NK-T7	
00-99151-1300W	C11-1300-150L	12.87~13.12	11	-	70.00	150		
00-99151-1400W	C11-1400-150L	13.87~14.12	11	-	70.00	150		
00-99151-1500W	C15.5-1500-180L	14.87~15.12	15.5	14	90.00	180	CC...0602... Screw: *NS-25060 / 0.9Nm Key:NK-T7	
00-99151-1600W	C15.5-1600-180L	15.87~16.12	15.5	15	90.00	180		
00-99151-1700W	C15.5-1700-180L	16.87~17.12	15.5	-	100.00	180		
00-99151-1800W	C15.5-1800-180L	17.87~18.12	15.5	-	100.00	180		
00-99151-1900W	C15.5-1900-180L	18.87~19.12	15.5	-	100.00	180		
00-99151-2000W	C15.5-2000-180L	19.87~20.12	15.5	-	100.00	180		

5

Boring Tool

*Torque screwdriver is recommended, see page 6-4.

Precisely Ground Inserts

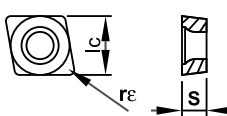
Inserts		Description	CCGT030102	CCGT040102	CCGH0602U	CCFT060204	CCFW060204	CCFT060204HP	
	NC30	K20F, TiAlN coated, universal grade for casting iron, carbon steel, alloy steel, stainless steel.	•	•					
	NC2032	K20F, AlTiN coated, for high speed cutting of casting iron.					•		
	NC2033	K20F, TiAlN coated, good for carbon steel, alloy steel, stainless steel.				•			
	NC9036	K20F, DLC coated, long tool life. Good for Al, Al-alloy, Copper and non-ferrous metal.	•	•				•	
	U-NC9036	K20F, DLC coated. It's a super finishing insert with large corner radius for high feed rate for cutting Al, Al-alloy and non-ferrous metal.			•				
Dimension 			l_c	3.5	4.3	6.35	6.35	6.35	6.35
			S	1.4	1.8	2.38	2.38	2.38	2.38
			r_e	0.2	0.2	-	0.4	0.4	0.4

Cutting Data

• Note: Super fine finishing insert **U-NC9036** with special specified cutting width **0.15mm**.(Radius) (see table below)

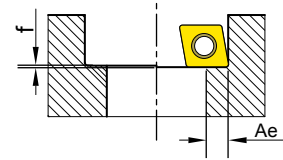

Spindle speed $S = \frac{V_c \times 1000}{\pi \times D}$ r.p.m. Feed rate: $f \times S$ mm/min.

Material	Cutting conditions or surface finishes	Grade of insert	Ae Max mm	Cutting Speed Vc(m/min.)	feed rate f (mm/rev.)
Carbon Steel	Regular cutting	NC2033	0.5	120-150-200	0.05-0.07-0.10
	Interrupted cutting	NC30	0.3	100-120-140	0.04-0.05-0.08
Alloy Steel	Regular cutting	NC2033	0.5	100-120-140	0.05-0.07-0.10
	Interrupted cutting	NC30	0.3	80-100-120	0.04-0.05-0.08
Stainless Steel	Regular cutting	NC2033	0.5	80-100-120	0.05-0.07-0.10
	Interrupted cutting	NC30	0.3	70-80-100	0.05-0.07-0.10
Cast Iron	Regular cutting	NC2032 NC30	0.5	80-100-120	0.05-0.07-0.10
Brass, Bronze and Al-alloy Si >6%	Regular cutting	NC9036	0.5	150-200-300	0.05-0.07-0.10
	Super mirror finish	U-NC9036	0.15	150-200-300	0.15-0.2-0.25
Al, Al-alloy, non-ferrous metal	Regular cutting	NC9036	0.5	150-200-300	0.05-0.07-0.10
	Super mirror finish	U-NC9036	0.15	150-200-300	0.15-0.20-0.25
Hardened Steel <HRC 50	Regular cutting	NC30	0.3	80-100-120	0.04-0.06-0.08

Direct Adjusting Boring Bar

No Backlash!
Micrometric Adjustment!
Extra long!

The Patented tool structure applies bit angle variation to produce slight size variation in diametric direction.

Excellent for applications on single size boring tools, deep hole boring tools, special tools, etc. It features easy control of μ accuracy.

5

Boring Tool



USA Patent



Direct Adjusting Boring Bar

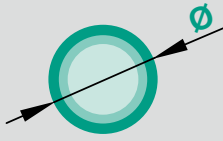

Diameter range:
13.9mm ~ 50.1mm



Adjustment range:
+0.1 / -0.1mm.

Direct Adjusting Boring Bar Family

00-99021:

Boring bar with direct adjustment :
Adjustment range ± 0.1 ,
 $\varnothing 15.9\text{mm} \sim \varnothing 50.1\text{mm}$ boring head.



00-99043:

Screw fit boring head with direct adjustment
for anti-vibration extension bar :
Adjustment range ± 0.1 ,
 $\varnothing 13.9\text{mm} \sim \varnothing 25.1\text{mm}$ boring head.



Feature

- Patented adjustment mechanism, to push insert directly by wedge and screw after insert clamped.
- The boring diameter is adjusted by pushing the micrometric adjustment screw after the insert screw has been tightened.
- There is no backlash while adjusting boring diameter.

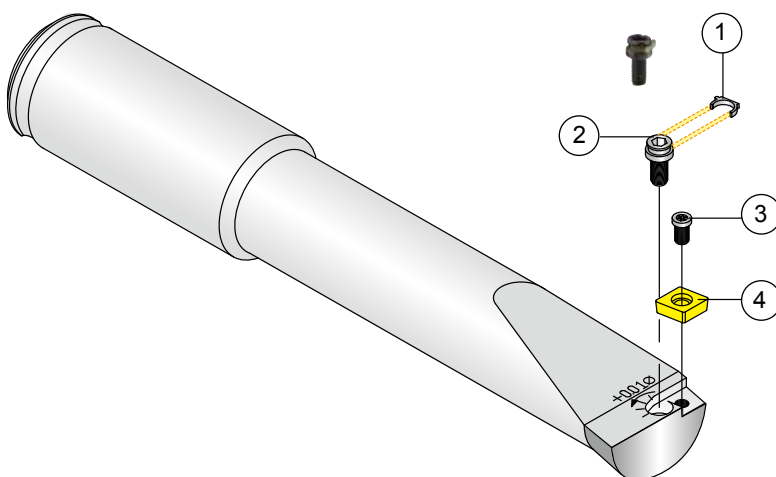

- ① Slide wedge
- ② Micrometric adjustment screw
- ③ Insert lock screw
- ④ Insert

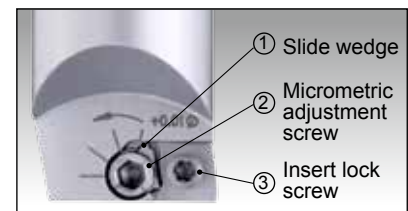

5

Boring Tool

Direct Adjusting Boring Bar

Cylindrical Shank

- Patented adjustment mechanism, to push insert directly by wedge and screw after insert clamped.
- Good for machining centers and special purpose machine for micrometric adjustment.

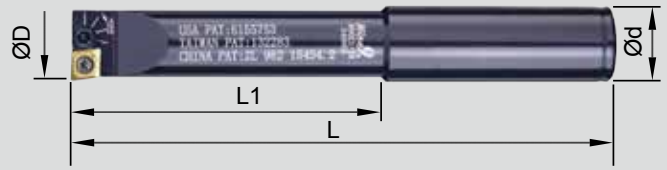

Ø16 ~ Ø50, Alloy Steel Shank

- Boring depth: L1, 4xD.
- Total adjustment range: 0.2mm.

Part No.	Type	ØD	Ød	L1	L	Insert / Screw	Adjustment Screw
00-99021-16	BC16-FB16	15.9~16.1	16	66	114	CC...0602... / Insert lock Screw: *NS-25060 / 0.9Nm Key:NK-T7 (2.5mm)	99021-A
00-99021-18	BC16-FB18	17.9~18.1	16	72	112		
00-99021-20	BC16-FB20	19.9~20.1	16	80	130		
00-99021-22	BC20-FB22	21.9~22.1	20	88	138		
00-99021-25	BC25-FB25	24.9~25.1	25	100	156		
00-99021-27	BC25-FB27	26.9~27.1	25	108	164	CC...09.... / Insert lock Screw: NS-35080 / 2.5Nm Key:NK-T15 (4mm)	99021-D
00-99021-28	BC25-FB28	27.9~28.1	25	112	168		
00-99021-30	BC25-FB30	29.9~30.1	25	120	176		
00-99021-32	BC25-FB32	31.9~32.1	25	128	184		
00-99021-35	BC32-FB35	34.9~35.1	32	140	200		
00-99021-37	BC32-FB37	36.9~37.1	32	140	200		
00-99021-40	BC32-FB40	39.9~40.1	32	140	200		
00-99021-42	BC32-FB42	41.9~42.1	32	140	200		
00-99021-45	BC32-FB45	44.9~45.1	32	140	200		
00-99021-47	BC32-FB47	46.9~47.1	32	140	200		
00-99021-50	BC32-FB50	49.9~50.1	32	140	200		

*Torque screwdriver is recommended, see page 6-4.

5

Boring Tool

Direct Adjusting Boring Bar

Screw Fit Boring head

- Integrated with direct adjustment for fine boring, adjustment range $\pm 0.1\text{mm}$.

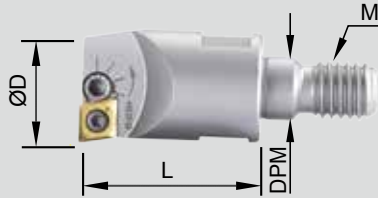

Part No.	Type	ØD	L	M	DPM	Insert / Screw	Adjustment screw
00-99043-14	M6-FB14	13.9~14.1	25	M6xP1.0	6.5	CC...0602... /	99021-A
00-99043-15	M6-FB15	14.9~15.1	25	M6xP1.0	6.5	Insert lock screw: *NS-25045 / 0.9Nm Key:NK-T7	
00-99043-16	M8-FB16	15.9~16.1	25	M8xP1.25	8.5	CC...0602... /	99021-A
00-99043-17	M8-FB17	16.9~17.1	25	M8xP1.25	8.5		
00-99043-18	M8-FB18	17.9~18.1	25	M8xP1.25	8.5		
00-99043-19	M8-FB19	18.9~19.1	30	M8xP1.25	8.5		
00-99043-20	M10-FB20	19.9~20.1	30	M10xP1.5	10.5		
00-99043-21	M10-FB21	20.9~21.1	30	M10xP1.5	10.5		
00-99043-22	M10-FB22	21.9~22.1	30	M10xP1.5	10.5		
00-99043-23	M10-FB23	22.9~23.1	30	M10xP1.5	10.5		
00-99043-24	M10-FB24	23.9~24.1	30	M10xP1.5	10.5		
00-99043-25	M10-FB25	24.9~25.1	30	M10xP1.5	10.5		

*Torque screwdriver is recommended, see page 6-4.

Steel Extension Bar

- T is the maximum overhang length.
- With internal coolant hole.

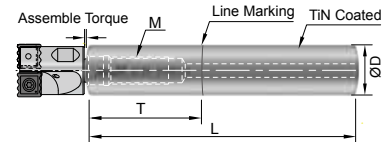

Parts No.	Type	ØD	T	L	M	Assemble Torque
00-99801-12S	BC12-075M06S	12	25	75	M6xP1.0	11.0 Nm
00-99801-14S	BC14-090M08S	14	30	90	M8xP1.25	25.0 Nm
00-99801-16S	BC16-090M08S	16	35	90	M8xP1.25	25.0 Nm
00-99801-18S	BC18-100M10S	18	40	100	M10xP1.5	50.0 Nm
00-99801-20S	BC20-100M10S	20	40	100	M10xP1.5	50.0 Nm
00-99801-25S	BC25-120M12S	25	50	120	M12xP1.75	60.0 Nm

Solid Carbide Extension Bar

- T is the maximum overhang length.
- With internal coolant hole.
- Carbide extension bar with longer tool length is available on request. (REVA brand)

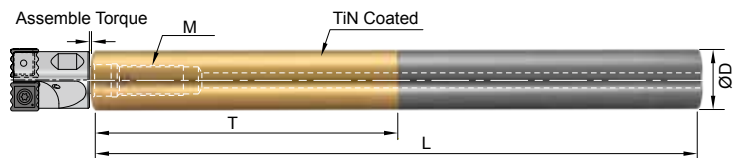

Parts No.	Type	ØD	T	L	M	Assemble Torque
00-99801-12W	BC12-100M06W	12	60	100	M6xP1.0	11.0 Nm
00-99801-14W	BC14-120M08W	14	70	120	M8xP1.25	25.0 Nm
00-99801-16W	BC16-150M08W	16	80	150	M8xP1.25	25.0 Nm
00-99801-18W	BC18-150M10W	18	90	150	M10xP1.5	50.0 Nm
00-99801-20W	BC20-200M10W	20	100	200	M10xP1.5	50.0 Nm
00-99801-25W	BC25-200M12W	25	125	200	M12xP1.75	60.0 Nm

5

Boring Tool

Procedures For Adjustment

- Extension bar is TiN coated to show the maximum usable boring length.



On Tool Presetter

1. Turn **screw-2** clockwise to the **bottom end** before tighten the insert.
2. Tighten the insert by **screw 1**.
(If you have tool presetter, follow step 3-5; if you don't, jump to step 6-9.)
3. Put the boring bar on the spindle of the tool presetter.
4. Measure the diameter of the boring bar by tool presetter; it should be smaller than nominal diameter. Adjusting the diameter of the boring bar by turning **screw-2** counter-clockwise using the Allen-key to increase diameter until required diameter is achieved.
5. If the diameter has been adjusted too big, please loosen the **screw-2**, and then **screw-1**. Repeat step 2-4 until the required diameter is achieved.
6. Put the boring bar on the machine spindle and make a test cut, about 5 mm deep. Measure hole diameter of the test cut.
7. Moving the boring bar to the tool diameter setter. The insert of the boring bar should touch the ceramic probe gently. Setting the dial gage to "zero" and adjust diameter by turning screw-2 counter-clockwise using the Allen key.
8. Read and note the "Adjusting amount" on the dial gage.
 $\text{Adjusting amount} = (\text{Nominal diameter} - \text{test cut diameter}) / 2$ (mm or inch.)
9. Make test cut and measure again until required adjusting amount is achieved.

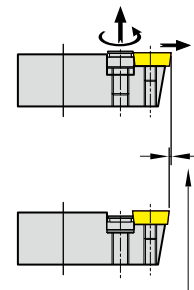
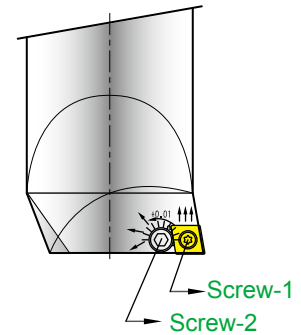

Adjusting Range 0.2 mm

5







Boring Tool

Adjusting boring diameter on the presetter.



Direction to increase boring diameter.

Precisely Ground Inserts

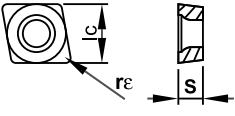
Inserts		Description	CCGH060204	CCFT060204	CCFW060204	CCGT09T304HP	
NC60		Cermet insert, for hardened steel and super finished of the high alloy steel.	•				
NC10		K20F carbide insert, TiAlN coated, for casting iron, carbon steel, alloy steel, stainless steel.				•	
K10		K10 carbide insert, high positive angle insert and fine polished on rake surface for Aluminum alloy and non-ferrous metal.				•	
NC2032		K20F carbide insert, AlTiN coated, for high speed cutting of casting iron.			•		
NC2033		K20F carbide insert, TiAlN coated, good for carbon steel, alloy steel, stainless steel.		•			
NC9036		K20F, DLC coated. It's a super finishing insert with large corner radius for high feed rate for cutting Al, Al-alloy and non-ferrous metal.		•			
Dimension 			L	6.35	6.35	6.35	9.52
			S	2.38	2.38	2.38	3.97
			rE	0.4	0.8	0.4	0.4

*Torque screwdriver is recommended, see page 6-4.

5

Boring Tool

Cutting Data

Spindle speed $S = \frac{V_c \times 1000}{\pi \times D}$ r.p.m. Feed rate: $f \times S$ mm/min

Material	Cutting conditions or surface finishes	Grade of insert	Cutting Speed V_c (m/min)	feed rate f (mm/rev.)
Carbon Steel	Regular cutting	NC60	120-150-180	0.05-0.07-0.10
	Interrupted cutting	NC2033 / NC10	100-120-140	0.04-0.05-0.08
Alloy Steel	Regular cutting	NC60	100-120-140	0.05-0.07-0.10
	Interrupted cutting	NC2033 / NC10	80-100-120	0.04-0.05-0.08
Stainless Steel	Regular cutting	NC2033 / NC10	70-80-100	0.05-0.07-0.10
Cast Iron	Regular cutting	NC10 / NC2032	80-100-120	0.05-0.07-0.10
Al, Al-alloy, non-ferrous metal	Regular cutting (DLC)	NC9036	150-200-300	0.05-0.07-0.10
	Regular cutting (Uncoated)	K10	150-200-300	0.05-0.07-0.10

Accessory

Contents

Page **6-2**
DC Slim Chuck



Page **6-3**
Extension Bar



Page **6-4**
Torque
Screwdriver



6

Accessory

DC Slim Chuck

► Extension Adaptor >>

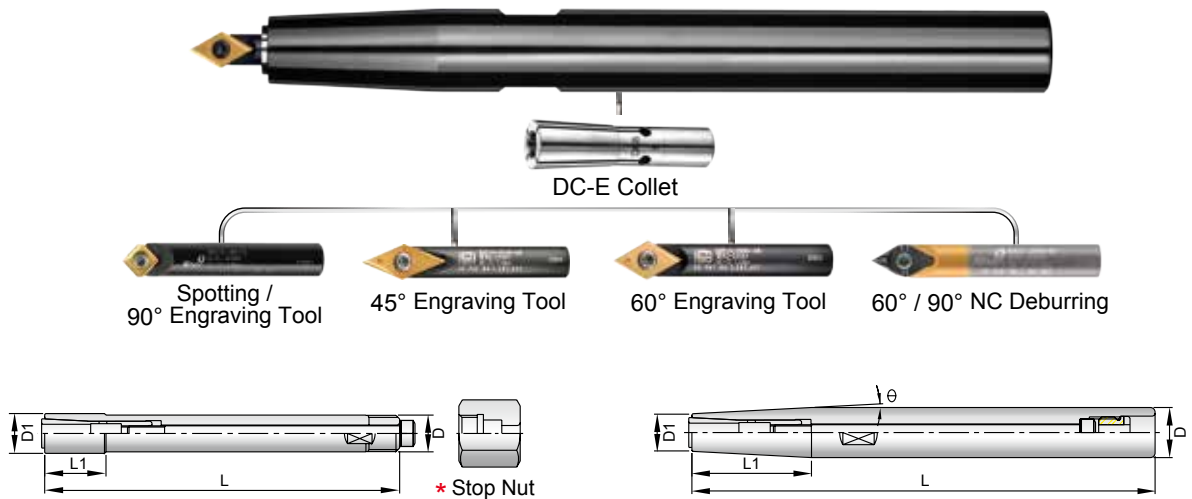

Parts No.	Type of Holder	d	L	L1	øD	D1	θ	Collet	Back Screw	Stop Screw	Hexagon Key	Stop Nut
0-329090-102	ST10-DC4-90	2~4	90	14	10	9	--	DC4	M4 * L60	--	0-301940~632	TP-M8
-112	ST12-DC4-120	2~4	120	38	12	9	3°		M4 * L85	OP-M8		
0-329090-212	ST12-DC6-120	2~6	120	40	12	14	--	DC6	M5 * L95	--	0-301940~642	TP-M12
-222	ST16-DC6-150	2~6	150	38	16	14	3°		M5 * L100	OP-M10		
-232	ST20-DC6-200	2~6	200	70	20	14	3°		M5 * L100	OP-M10		
-242	ST25-DC6-250	2~6	250	115	25	14	3°		M5 * L100	OP-M10		
0-329090-322	ST20-DC8-200	3~8	200	28	20	19	2°	DC8	M6 * L120	OP-M12	0-301940~652	--
0-329090-432	ST25-DC10-250	4~10	250	28	25	24	2°	DC10	M8 * L150	OP-M16	0-301940~662	--

* Stop nut is applied when clamping and unclamping tools.

► DC-E Collet >>

- The design of DC-E collets is emphasized on increasing the clamping force of end mills.

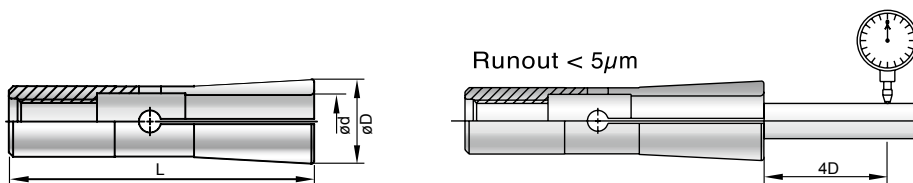

Type	DC-4E		DC-6E		DC-8E		DC-10E	
D	7		9.6		15		19.1	
L	31		36		45		52	
DC4-E		DC6-E		DC8-E		DC10-E		
Parts No.	Size(mm)	Parts No.	Size(mm)	Parts No.	Size(mm)	Parts No.	Size(mm)	
0-300090-102	2.0	0-300090-203	3.0	0-300090-303	3.0	-	-	
0-300090-103	3.0	0-300090-204	4.0	0-300090-304	4.0	0-300090-404	4.0	
0-300090-104	4.0	0-300090-206	6.0	0-300090-306	6.0	0-300090-406	6.0	
				0-300090-308	8.0	0-300090-408	8.0	
						0-300090-410	10.0	

Extension Bar

For NC Spot Drill, NC Helix Drill, Power Mill and Direct Adjusting Boring Bar

► Steel Type >>

- T is the maximum overhang length.
- With internal coolant hole.

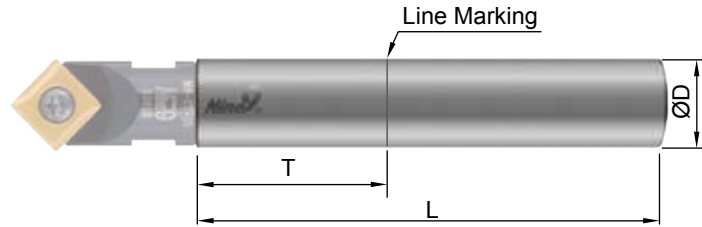

Part No.	Type	ØD	T	L	M	Assemble Torque
00-99801-12S	BC12-075M06S	12	25	75	M6xP1.0	11.0 Nm
00-99801-14S	BC14-090M08S	14	30	90	M8xP1.25	25.0 Nm
00-99801-16S	BC16-090M08S	16	35	90	M8xP1.25	25.0 Nm
00-99801-18S	BC18-100M10S	18	40	100	M10xP1.5	50.0 Nm
00-99801-20S	BC20-100M10S	20	40	100	M10xP1.5	50.0 Nm
00-99801-25S	BC25-120M12S	25	50	120	M12xP1.75	60.0 Nm

► Solid Carbide Type >>

- T is the maximum overhang length.
- With internal coolant hole.

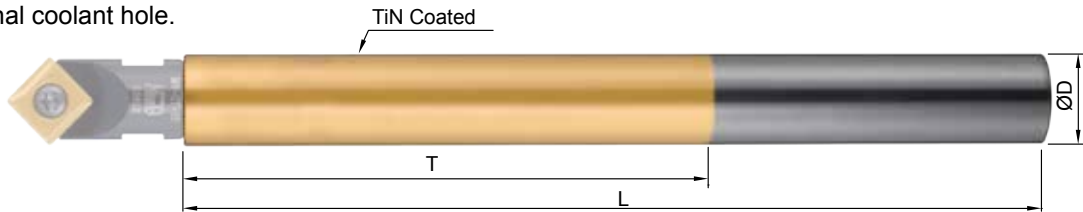

Part No.	Type	ØD	T	L	M	Assemble Torque
00-99801-10W	BC10-100M05W	10	50	100	M5xP0.8	6.5 Nm
00-99801-12W	BC12-100M06W	12	60	100	M6xP1.0	11.0 Nm
00-99801-14W	BC14-120M08W	14	70	120	M8xP1.25	25.0 Nm
00-99801-16W	BC16-150M08W	16	80	150	M8xP1.25	25.0 Nm
00-99801-18W	BC18-150M10W	18	90	150	M10xP1.5	50.0 Nm
00-99801-20W	BC20-200M10W	20	100	200	M10xP1.5	50.0 Nm
00-99801-25W	BC25-200M12W	25	125	200	M12xP1.75	60.0 Nm

► REVA Solid Carbide Extension Bar >>

- With internal coolant hole.
- Carbide extension bar with longer tool length is available on request.

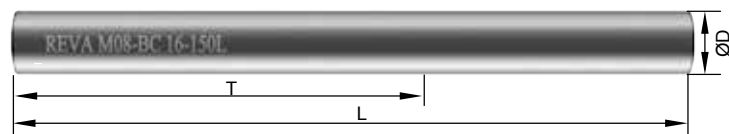

Parts No.	Type	ØD	T	L	M	Assembled Torque
0-398010-100M05	M05-BC10-100L	10	60	100	M5xP0.8	6.5 Nm
0-398012-100M06	M06-BC12-100L	12	60	100	M6xP1.0	11.0 Nm
0-398016-150M08	M08-BC16-150L	16	80	150	M8xP1.25	25.0 Nm
0-398020-200M10	M10-BC20-200L	20	100	200	M10xP1.5	50.0 Nm
0-398025-200M12	M12-BC25-200L	25	125	200	M12xP1.75	60.0 Nm

Torque Screwdriver

It prevents damages of the screws and tool



► Why Torque Control is important? >>

- Increase tool life of insert screw.
- Optimize performance of milling cutters after locking with identical torque on all inserts.
- Avoid damage of screw, resulted couldn't take insert out from the cutter.
- Deliver right tightening force to precise parts, no more over-tightening.
- Enhance the function of both tightened parts and connected parts.

► 0.6~5.5Nm torque screwdriver with 25mm+50mm TORX® high precision bit.

Parts No.	Contents						N.W.	Packaging Illustration
	Handle	Adapter			Bit			
		Nm	Kgcm	In-lb	Size	25mm+50mm		
0-TPK01-TX06-0.6-S	TPK-H02	0.6	6.1	5.3	TX6	2 pcs + 2 pcs	122g	
0-TPK01-TX07-0.9-S		0.9	9.2	8.0	TX7			
0-TPK01-TX08-1.2-S		1.2	12.0	10.6	TX8			
0-TPK01-TX08-2.0	TPK-H01	2.0	20.4	17.7	TX8	2 pcs + 2 pcs	130g	
0-TPK01-TX09-1.4		1.4	14.0	12.4	TX9			
0-TPK01-TX09-2.0		2.0	20.4	17.7	TX9			
0-TPK01-TX10-2.0		2.0	20.4	17.7	TX10			
0-TPK01-TX15-3.0		3.0	30.6	26.6	TX15			
0-TPK01-TX20-5.0	TPK-H03	5.0	51.0	44.3	TX20	2 pcs	200g	
0-TPK01-TX20-5.5		5.5	56.1	48.7	TX20			
0-TPK01-TX2025-5.5								
					Bit 50mm			
					TX20	2 pcs		
					TX25	2 pcs		

Note: other size are available, please feel free to contact us.

6

Accessory

Notes

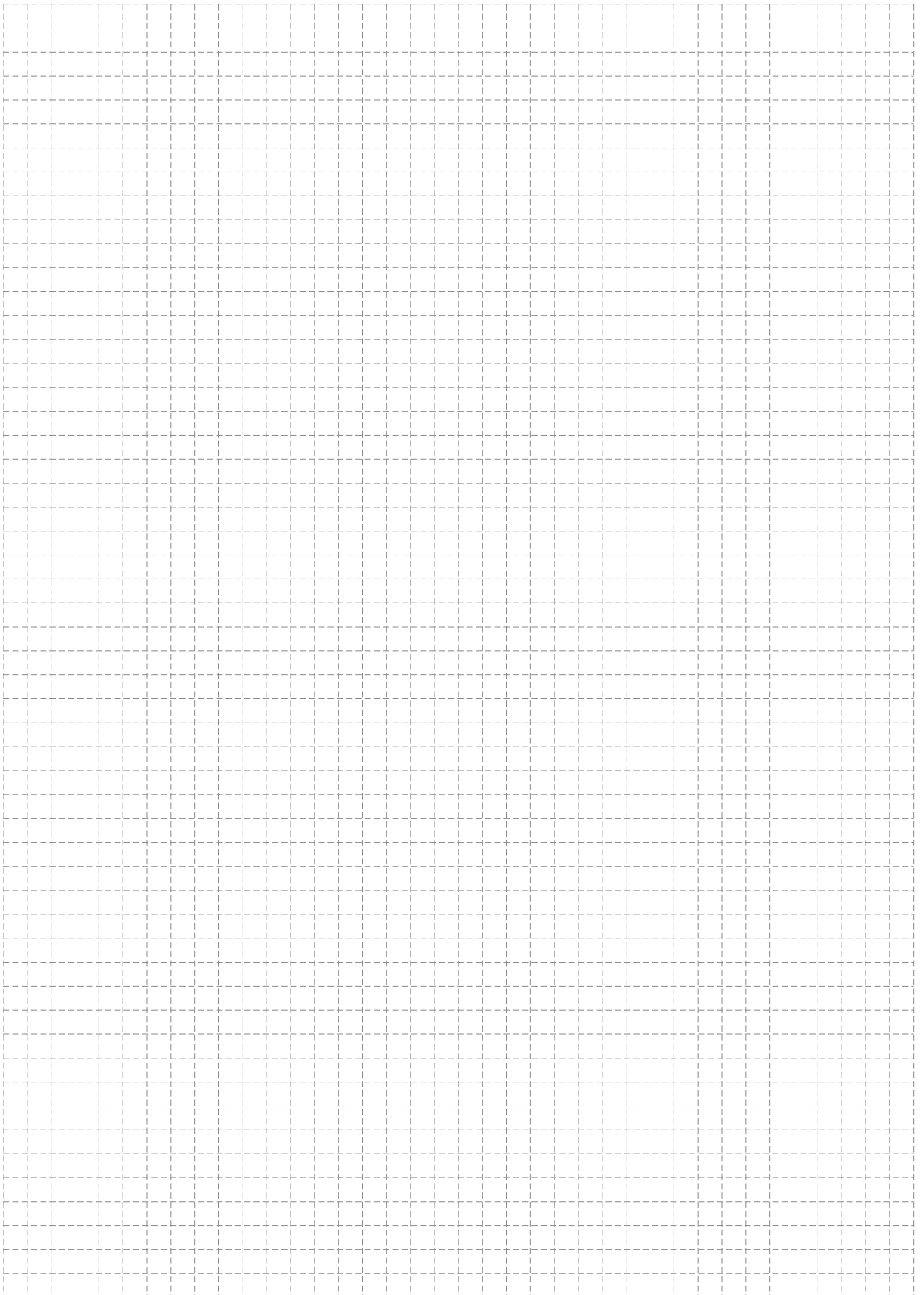



No Need To Choose
Nine9 Does It All

