

boehlerit

Drehbearbeitung von
Rostfreimaterialien
Machining of
stainless steel materials

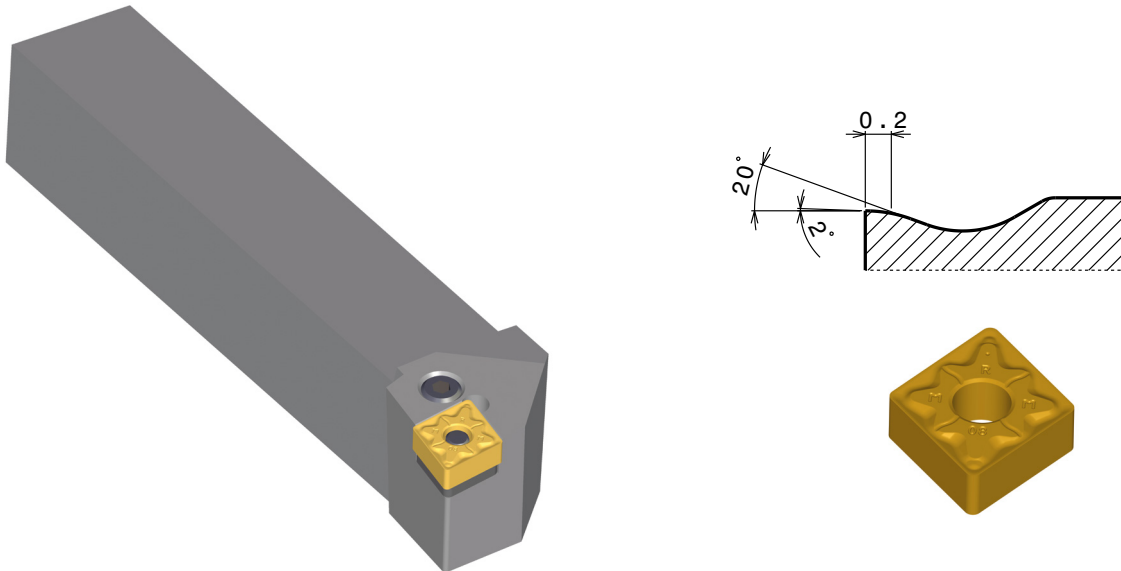

Programmerweiterung
Programme extension



Mit der neuesten Wendeschneidplatten-Geometrie „MRM“, ergänzt Boehlerit das ISO Drehprogramm im mittleren bis schweren Schrupp-Bereich für rostfreie Materialien und setzt neue Maßstäbe. Damit stehen in breiten Anwendungsbereichen auf rostfreien Stählen optimale Wendeschneidplatten Geometrien zur Verfügung.

Der neue Spanbrecher „MRM“ ist eine Ergänzung der am Markt etablierten „BMRS“, Geometrie welche zwar einen ähnlichen Vorschubbereich kennzeichnet, sich durch den tieferen Spanwinkel jedoch stark in der Mikro-Geometrie unterscheidet. Somit wird eine Verringerung der Schnittkräfte erreicht, woraus sowohl eine Erhöhung der Prozesssicherheit, als auch eine Standzeiterhöhung auf rostfreien Stählen mit hohen Härtegraden resultieren.

Der neue Spanformer der MRM-Geometrie, mit einem Vorschubbereich von 0,20 - 0,50 mm/U, ist eine optimale Erweiterung zur erfolgreichen „MM“ Geometrie, die einen (überlappenden) Vorschubbereich von 0,15 - 0,35 mm/U aufweist.

Für die neue MRM Wendeschneidplattengeometrie sind folgende Werkstoffsorten verfügbar:

LCM20T mittleres Substrat mit dünner CVD-Beschichtung
BCM25T mittleres Substrat mit dicker PVD Beschichtung
BCM40T zähes Substrat mit dicker PVD Beschichtung

With its latest indexable insert geometry MRM, Boehlerit has added yet another innovation to its ISO turning programme for the medium to rough machining of stainless materials, setting new standards in the process and making optimised indexable inserts available for a wide range of applications using stainless steels.

The new MRM chip breaker complements the BMRS geometry, which is well established on the market and covers a similar feed rate range but differs in terms of micro geometry due to the deeper chipping angle. In this way, the cutting forces are reduced, resulting in increased process safety and a increased tool life on stainless steels with high hardness levels.

In addition, the new chip former with feed rates of 0.20 - 0.50 mm/rev is the ideal extension to the successful MM geometry with an overlapping feed rate range of 0.15 - 0.35 mm/rev.

The following material grades are available for the new MRM indexable insert geometry:

LCM20T medium substrate with thin CVD coating
BCM25T medium substrate with thick PVD coating
BCM40T tough substrate with thick PVD coating

Wendeschneidplatten für die Bearbeitung von rostfreien Stählen
Indexable inserts for machining stainless steels

www.boehlerit.com

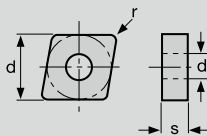
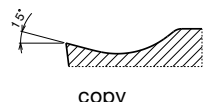
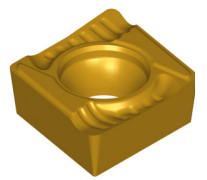
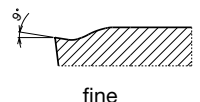
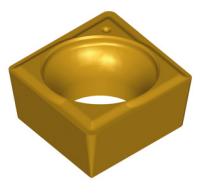
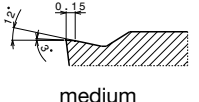
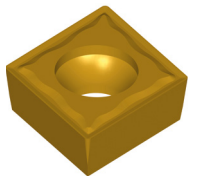
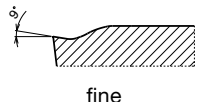
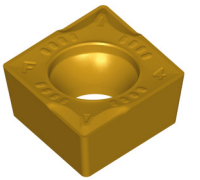
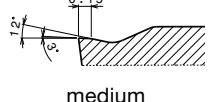
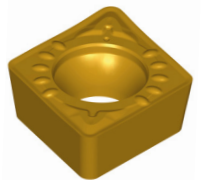
	Sorte Grade			ISO-Klasse ISO-class	
	LCM20T LC435D BCM25T BCM40T			HC-M20 HC-M35 HC-M25 HC-M40	
CCGT....-E.-BC  copy 	CCGT....-FM  fine 	CCMT....-BSMS  medium 	CCMT....-FM  fine 	CCMT....MM  medium 	

Type Type	Geometrie Geometry	Vorschub Feed f [mm / U rev]	Schnitttiefe cutting depth ap max. [mm]	Abmessungen [mm] Dimensions [mm]			LCM20T	LC435D	BCM25T	BCM40T
				d	s	r				
CCGT 060204	EL-BC	0,10 - 0,25	0,40 - 2,50	6,35	2,38	0,4		6413126		
CCGT 060204	ER-BC	0,10 - 0,25	0,40 - 2,50	6,35	2,38	0,4		6413130		
CCGT 060208	EL-BC	0,10 - 0,30	0,80 - 2,50	6,35	2,38	0,8		6413134		
CCGT 060208	ER-BC	0,10 - 0,30	0,80 - 2,50	6,35	2,38	0,8		6413138		
CCGT 09T304	EL-BC	0,10 - 0,25	0,40 - 3,00	9,52	3,97	0,4		6413139		
CCGT 09T304	ER-BC	0,10 - 0,25	0,40 - 3,00	9,52	3,97	0,4		6413140		
CCGT 09T308	EL-BC	0,20 - 0,45	0,80 - 3,00	9,52	3,97	0,8		6413141		
CCGT 09T308	ER-BC	0,20 - 0,45	0,80 - 3,00	9,52	3,97	0,8		6413142		
CCGT 120408	ER-BC	0,20 - 0,45	0,80 - 4,00	12,7	4,76	0,8		6413150		
CCGT 120412	EL-BC	0,20 - 0,45	1,20 - 4,00	12,7	4,76	1,2		6413154		
CCGT 030101	FM	0,02 - 0,06	0,10 - 0,80	3,52	1,4	0,1			5140563	
CCGT 030102	FM	0,05 - 0,13	0,20 - 1,50	3,52	1,4	0,2			5140564	
CCMT 09T304	BSMS	0,10 - 0,25	0,40 - 3,00	9,52	3,97	0,4		6400352		
CCMT 09T308	BSMS	0,12 - 0,30	0,80 - 3,00	9,52	3,97	0,8		6400353		
CCMT 120404	BSMS	0,12 - 0,30	0,40 - 4,00	12,7	4,76	0,4		6400354		
CCMT 120408	BSMS	0,15 - 0,35	0,80 - 4,00	12,7	4,76	0,8		6400355		
CCMT 060202	FM	0,06 - 0,13	0,20 - 2,50	6,35	2,38	0,2			5106897	5106721
CCMT 060204	FM	0,08 - 0,15	0,40 - 2,50	6,35	2,38	0,4			5106898	5106896
CCMT 09T304	FM	0,08 - 0,20	0,40 - 3,00	9,52	3,97	0,4	5093104	5073343	5166564	
CCMT 060202	MM	0,07 - 0,13	0,20 - 2,50	6,35	2,38	0,2	5093105	5073333	5090769	
CCMT 060204	MM	0,10 - 0,25	0,40 - 2,50	6,35	2,38	0,4	5093106	5064302	5090778	
CCMT 09T304	MM	0,10 - 0,25	0,40 - 3,00	9,52	3,97	0,4	5064531		5090779	
CCMT 09T308	MM	0,15 - 0,40	0,80 - 3,00	9,52	3,97	0,8	5064532		5090780	
CCMT 120404	MM	0,15 - 0,40	0,40 - 4,00	12,7	4,76	0,4			5090782	
CCMT 120408	MM	0,15 - 0,40	0,80 - 4,00	12,7	4,76	0,8			5090783	

Bestellbeispiel Order example: 10 Stück 10 pieces CCGT 060204-EL-BC LC435D oder or 6413126
 Abbildung der Wendeschneidplatten können vom Lagerartikel in Ausführung und Farbe abweichen!
 Colours and execution of the original indexable inserts, may deviate from the illustration!





Verfügbar ab Lager Available from stock

		Sorte Grade				ISO-Klasse ISO-class	
		LCM20T LC435D BCM25T BCM40T				HC-M20 HC-M35 HC-M25 HC-M40	
CNMG....-BFMS medium fine 	CNMG....-BMRS medium rough 	CNMG....-BMS medium 	CNMG.... E.-BC copy 	CNMG.... MM medium 	CNMG....MRM medium rough 		

Type Type	Geometrie Geometry	Vorschub Feed f [mm / U rev]	Schnitttiefe cutting depth ap max. [mm]	Abmessungen [mm] Dimensions [mm]			LCM20T	LC435D	BCM25T	BCM40T
				d	s	r				
CNMG 090304	BFMS	0,10 - 0,30	0,40 - 3,00	9,52	3,18	0,4	5093116	6400356	5090787	
CNMG 120404	BFMS	0,10 - 0,30	0,40 - 4,50	12,7	4,76	0,4	5093117	6400357	5090790	
CNMG 120408	BFMS	0,10 - 0,30	0,80 - 4,50	12,7	4,76	0,8	5093119	6400358	5090791	
CNMG 120412	BFMS	0,10 - 0,30	0,80 - 4,50	12,7	4,76	0,8	5090794	6400359	5093120	
CNMG 120408	BMRS	0,15 - 0,40	0,80 - 5,00	12,7	4,76	0,8		6400363	5107398	5102375
CNMG 120412	BMRS	0,15 - 0,40	1,20 - 5,00	12,7	4,76	1,2		6400364	5107406	5102373
CNMG 160612	BMRS	0,32 - 0,70	1,20 - 9,00	15,87	6,35	1,2		6400365	5107400	5092797
CNMG 160616	BMRS	0,32 - 0,70	1,60 - 9,00	15,87	6,35	1,6			5107397	5093135
CNMG 190612	BMRS	0,32 - 0,70	1,20 - 12,0	19,05	6,35	1,2		6400417	5107405	5092822
CNMG 120408	BMS	0,16 - 0,40	0,80 - 5,00	12,7	4,76	0,8		6400360		
CNMG 120412	BMS	0,16 - 0,40	1,20 - 5,00	12,7	4,76	1,2		6400361		
CNMG 160612	BMS	0,16 - 0,40	1,20 - 9,00	15,87	6,35	1,2		6400362		
CNMG 120404	EL-BC	0,10 - 0,25	1,20 - 5,00	12,7	4,76	0,4		6410867		
CNMG 120404	ER-BC	0,10 - 0,25	1,20 - 5,00	12,7	4,76	0,4		6410871		
CNMG 120408	EL-BC	0,20 - 0,45	0,80 - 5,00	12,7	4,76	0,8		6410875		
CNMG 120408	ER-BC	0,20 - 0,45	0,80 - 5,00	12,7	4,76	0,8		6410879		
CNMG 120408	MM	0,15 - 0,40	0,80 - 4,00	12,7	4,76	0,8	5047846		5090793	5093132
CNMG 120412	MM	0,15 - 0,40	1,20 - 4,00	12,7	4,76	1,2	5047848		5091978	5093134
CNMG 160612	MM	0,15 - 0,40	1,20 - 9,00	15,87	6,35	1,2	5074538		5092372	5092802
CNMG 160616	MM	0,15 - 0,40	1,60 - 9,00	15,87	6,35	1,6	5074537		5092377	5092821
CNMG 190612	MM	0,15 - 0,40	1,20 - 12,0	19,05	6,35	1,2	5074485		5166566	5092853
CNMG 190616	MM	0,15 - 0,40	1,60 - 12,0	19,05	6,35	1,6	5074529		5166567	5092861
CNMG 120408	MRM	0,20 - 0,50	0,80 - 5,00	12,7	4,76	0,8	5151880		5151881	5151883
CNMG 120412	MRM	0,20 - 0,50	1,20 - 5,00	12,7	4,76	1,2	5151885		5151886	5151888
CNMG 160608	MRM	0,20 - 0,50	0,80 - 9,00	15,87	6,35	0,8	5151889		5151890	5151894
CNMG 160612	MRM	0,20 - 0,50	1,20 - 9,00	15,87	6,35	1,2	5151895		5151897	5151902

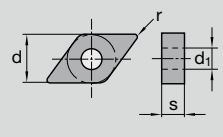
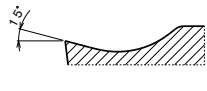
Wendeschneidplatten für die Bearbeitung von rostfreien Stählen
Indexable inserts for machining stainless steels

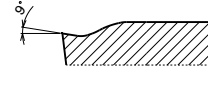
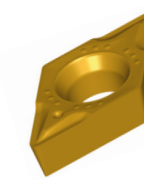
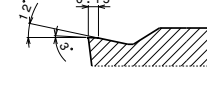
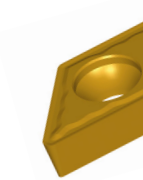
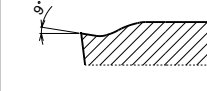
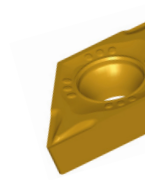
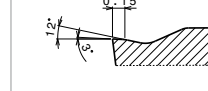
www.boehlerit.com

	Sorte Grade				ISO-Klasse ISO-class
	LCM20T LC435D BCM25T BCM40T				HC-M20 HC-M35 HC-M25 HC-M40
DCGT...E.-BC  copy 	DCGT....-FM  fine 	DCMT....-BSMS  medium 	DCMT....-FM  fine 	DCMT....-MM  medium 	

Type Type	Geometrie Geometry	Vorschub Feed f [mm / U rev]	Schnitttiefe cutting depth ap max. [mm]	Abmessungen [mm] Dimensions [mm]			LCM20T	LC435D	BCM25T	BCM40T
				d	s	r				
DCGT 070204	EL-BC	0,10 - 0,28	0,40 - 1,50	6,35	2,38	0,4		6413173		
DCGT 070204	ER-BC	0,10 - 0,28	0,40 - 1,50	6,35	2,38	0,4		6413177		
DCGT 11T304	EL-BC	0,10 - 0,28	0,40 - 2,00	9,52	3,97	0,4		6413178		
DCGT 11T304	ER-BC	0,10 - 0,28	0,40 - 2,00	9,52	3,97	0,4		6413179		
DCGT 11T308	EL-BC	0,20 - 0,45	0,80 - 2,00	9,52	3,97	0,8		6413180		
DCGT 11T308	ER-BC	0,20 - 0,45	0,80 - 2,00	9,52	3,97	0,8		6413181		
DCGT 04T002	FM	0,05 - 0,13	0,20 - 1,50	3,12	1,2	0,2			5131355	
DCMT 11T304	BSMS	0,15 - 0,25	0,40 - 2,00	9,52	3,97	0,4		6400366		
DCMT 11T308	BSMS	0,20 - 0,50	0,80 - 2,00	9,52	3,97	0,8		6400367		
DCMT 070202	FM	0,05 - 0,13	0,20 - 1,50	6,35	2,38	0,2	5093121	5076858	5166570	
DCMT 070204	FM	0,07 - 0,20	0,20 - 1,50	6,35	2,38	0,4			5106904	5106901
DCMT 11T302	FM	0,05 - 0,15	0,20 - 2,00	9,52	3,97	0,2	5085216	5077020	5166572	
DCMT 11T304	FM	0,07 - 0,20	0,40 - 2,00	9,52	3,97	0,4			5106906	5106905
DCMT 070204	MM	0,15 - 0,25	0,40 - 1,50	6,35	2,38	0,4		5064311	5166568	
DCMT 11T304	MM	0,15 - 0,25	0,40 - 2,00	9,52	3,97	0,4	5064535		5092380	
DCMT 11T308	MM	0,15 - 0,40	0,80 - 2,00	9,52	3,97	0,8	5064533		5092382	

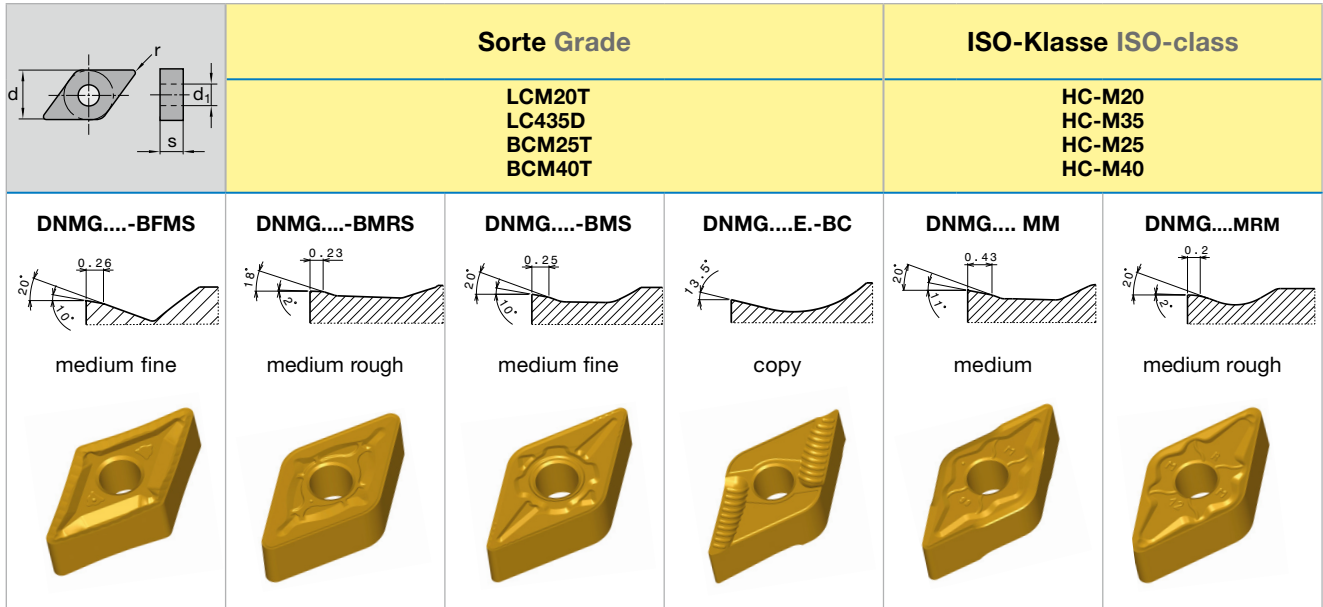

Type Type	Geometrie Geometry	Vorschub Feed f [mm / U rev]	Schnitttiefe cutting depth ap max. [mm]	Abmessungen [mm] Dimensions [mm]			LCM20T	LC435D	BCM25T	BCM40T
				d	s	r				
DNMG 110404	BFMS	0,10 - 0,30	0,40 - 4,50	9,52	3,97	0,4	5093128	6400368	5092387	
DNMG 110408	BFMS	0,10 - 0,30	0,80 - 4,50	9,52	3,97	0,8			5092488	
DNMG 150604	BFMS	0,10 - 0,30	0,40 - 6,00	12,7	6,35	0,4	5093130	6400369	5092639	
DNMG 150608	BFMS	0,10 - 0,30	0,80 - 6,00	12,7	6,35	0,8	5093131	6400370	5092641	
DNMG 150608	BMRS	0,32 - 0,70	0,80 - 6,00	12,7	6,35	0,8		6400408	5107402	5101436
DNMG 150612	BMRS	0,32 - 0,70	1,20 - 6,00	12,7	6,35	1,2		6400375	5107403	5092864
DNMG 110408	BMS	0,14 - 0,35	0,80 - 4,50	9,52	3,97	0,8		6400372		
DNMG 150408	BMS	0,16 - 0,40	0,80 - 6,00	12,7	4,76	0,8		6400445		
DNMG 150608	BMS	0,16 - 0,40	0,80 - 6,00	12,7	6,35	0,8		6400373		
DNMG 150612	BMS	0,16 - 0,40	1,20 - 6,00	12,7	6,35	1,2		6400374		
DNMG 150604	EL-BC	0,15 - 0,35	0,40 - 6,00	12,7	6,35	0,4		6400785		
DNMG 150604	ER-BC	0,15 - 0,35	0,40 - 6,00	12,7	6,35	0,4		6400786		
DNMG 150608	EL-BC	0,20 - 0,45	0,80 - 6,00	12,7	6,35	0,8		6400787		
DNMG 150608	ER-BC	0,20 - 0,45	0,80 - 6,00	12,7	6,35	0,8		6400788		
DNMG 110404	MM	0,15 - 0,30	0,40 - 4,50	9,52	3,97	0,4			5092413	
DNMG 110408	MM	0,15 - 0,30	0,80 - 4,50	9,52	3,97	0,8			5092416	
DNMG 150404	MM	0,12 - 0,35	0,40 - 6,00	12,7	4,76	0,4	5079009		5093129	
DNMG 150408	MM	0,15 - 0,40	0,80 - 6,00	12,7	4,76	0,8	5078339		5092497	
DNMG 150604	MM	0,12 - 0,35	0,40 - 6,00	12,7	6,35	0,4	5078794		5101437	
DNMG 150608	MM	0,15 - 0,40	0,80 - 6,00	12,7	6,35	0,8	5047849		5092642	5092863
DNMG 150612	MM	0,15 - 0,40	1,20 - 6,00	12,7	6,35	1,2	5060170		5092726	5092866
DNMG 150608	MRM	0,20 - 0,50	0,8 - 5,0	12,7	6,35	0,8	5151903		5151904	5151906
DNMG 150612	MRM	0,20 - 0,50	1,2 - 5,0	12,7	6,35	1,2	5151907		5151908	5151910

Wendeschneidplatten für die Bearbeitung von rostfreien Stählen
Indexable inserts for machining stainless steels

www.boehlerit.com

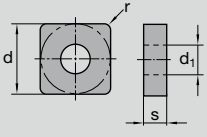
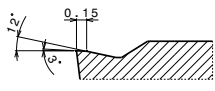
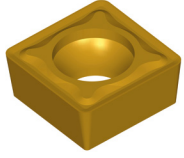
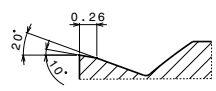
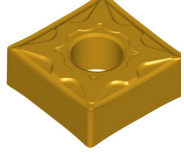
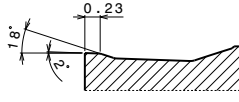
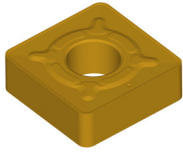
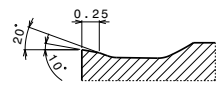
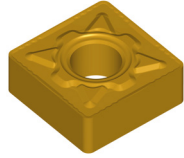
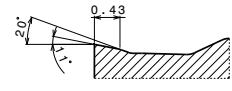
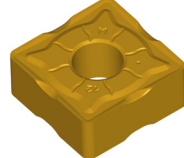
	Sorte Grade				ISO-Klasse ISO-class
	LCM20T LC435D BCM25T BCM40T				HC-M20 HC-M35 HC-M25 HC-M40
SCMT...BSMS  medium 	SNMG...-BFMS  medium fine 	SNMG....-BMRS  medium rough 	SNMG....-BMS  medium 	SNMG....-MM  medium 	

Type Type	Geometrie Geometry	Vorschub Feed f [mm / U rev]	Schnitttiefe cutting depth ap max. [mm]	Abmessungen [mm] Dimensions [mm]			LCM20T	LC435D	BCM25T	BCM40T
				d	s	r				
SCMT 120408	BSMS	0,20 - 0,50	0,80 - 3,50	12,7	4,76	0,8		6400376		
SNMG 090304	BFMS	0,10 - 0,30	0,40 - 4,50	9,52	3,18	0,4		6400377	5092728	
SNMG 120408	BMRS	0,32 - 0,60	0,80 - 7,00	12,7	4,76	0,8		6400380		
SNMG 120412	BMRS	0,32 - 0,70	1,20 - 7,00	12,7	4,76	1,2		6400421		5092867
SNMG 190612	BMRS	0,32 - 0,70	1,20 - 10,0	19,05	6,35	1,2		6400422	5168815	5092893
SNMG 190616	BMRS	0,32 - 0,70	1,60 - 10,0	12,7	4,76	1,6			5168816	5092902
SNMG 120408	BMS	0,16 - 0,40	0,80 - 7,00	12,7	4,76	0,8		6400378		
SNMG 120412	BMS	0,16 - 0,40	1,20 - 7,00	12,7	4,76	1,2		6400379		
SNMG 120408	MM	0,15 - 0,40	0,80 - 7,00	12,7	4,76	0,8			5092732	5101438
SNMG 120412	MM	0,15 - 0,40	1,20 - 7,00	12,7	4,76	1,2			5092733	5101439
SNMG 150612	MM	0,15 - 0,40	1,20 - 7,50	15,87	6,35	1,2	5074534		5092737	5092889
SNMG 150616	MM	0,15 - 0,40	1,60 - 7,50	15,87	6,35	1,6	5074531		5092747	5092892
SNMG 190612	MM	0,15 - 0,40	1,20 - 10,0	19,05	6,35	1,2	5074536		5166574	5092901
SNMG 190616	MM	0,15 - 0,40	1,60 - 10,0	19,05	6,35	1,6	5074535		5166576	5092946

Bestellbeispiel Order example: 10 Stück 10 pieces SCMT 120408-BSMS LC435D oder or 6400376









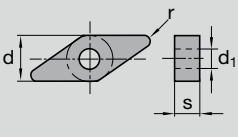
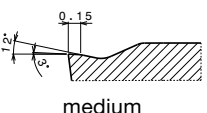

Verfügbar ab Lager Available from stock

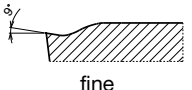
	Sorte Grade				ISO-Klasse ISO-class
	LCM20T LC435D BCM25T BCM40T				HC-M20 HC-M35 HC-M25 HC-M40
TCGT....-E-BC medium 	TCMT....-BSMS medium 	TNMG....-BFMS medium fine 	TNMG....-BMS medium rough 	TNMG....E-BC copy 	

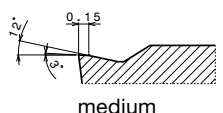
Type Type	Geometrie Geometry	Vorschub Feed f [mm / U rev]	Schnitttiefe cutting depth ap max. [mm]	Abmessungen [mm] Dimensions [mm]			LCM20T	LC435D	BCM25T	BCM40T
				d	s	r				
TCGT 110204	EL-BC	0,10 - 0,25	0,40 - 2,00	6,35	2,38	0,4		6413218		
TCGT 16T304	EL-BC	0,10 - 0,25	0,40 - 3,00	9,52	3,97	0,4		6413226		
TCGT 16T304	ER-BC	0,10 - 0,25	0,40 - 3,00	9,52	3,97	0,4		6413230		
TCGT 16T308	EL-BC	0,15 - 0,30	0,80 - 3,00	9,52	3,97	0,8		6413234		
TCGT 16T308	ER-BC	0,15 - 0,30	0,80 - 3,00	9,52	3,97	0,8		6413238		
TCMT 110204	BSMS	0,10 - 0,25	0,40 - 2,00	6,35	2,38	0,4		6400381		
TCMT 110208	BSMS	0,10 - 0,30	0,80 - 2,00	6,35	2,38	0,8		6400382		
TCMT 16T304	BSMS	0,10 - 0,25	0,40 - 3,00	9,52	3,97	0,4		6400383		
TCMT 16T308	BSMS	0,15 - 0,35	0,80 - 3,00	9,52	3,97	0,8		6400384		
TNMG 160404	BFMS	0,10 - 0,30	0,40 - 6,00	9,52	4,76	0,4		6400385	5092749	
TNMG 160408	BFMS	0,10 - 0,30	0,80 - 6,00	9,52	4,76	0,8		6400386	5092750	
TNMG 160408	BMS	0,16 - 0,40	0,80 - 6,00	9,52	4,76	0,8		6400424	5092757	
TNMG 160412	BMS	0,16 - 0,40	1,20 - 6,00	9,52	4,76	1,2		6400425	5092759	
TNMG 220408	BMS	0,16 - 0,40	0,80 - 7,00	12,7	4,76	0,8		6400387	5092761	
TNMG 220412	BMS	0,16 - 0,40	1,20 - 7,00	12,7	4,76	1,2		6400407	5092766	
TNMG 160404	EL-BC	0,10 - 0,25	0,40 - 6,00	9,52	4,76	0,4			6411834	
TNMG 160404	ER-BC	0,10 - 0,25	0,40 - 6,00	9,52	4,76	0,4			6411838	
TNMG 160408	EL-BC	0,15 - 0,35	0,80 - 6,00	9,52	4,76	0,8			6410957	
TNMG 160408	ER-BC	0,15 - 0,35	0,80 - 6,00	9,52	4,76	0,8			6410961	

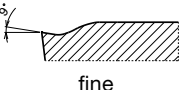
Wendeschneidplatten für die Bearbeitung von rostfreien Stählen
Indexable inserts for machining stainless steels

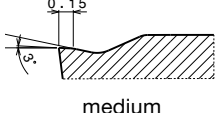
www.boehlerit.com

	Sorte Grade				ISO-Klasse ISO-class
	LCM20T LC435D BCM25T BCM40T				HC-M20 HC-M35 HC-M25 HC-M40
VBMT....-MM  medium 	VCGT....-FM  fine 	VCMT....-BSMS  medium 	VCMT....-FM  fine 	VCMT....-MM  medium 	

Type Type	Geometrie Geometry	Vorschub Feed f [mm / U rev]	Schnitttiefe cutting depth ap max. [mm]	Abmessungen [mm] Dimensions [mm]			LCM20T	LC435D	BCM25T	BCM40T
				d	s	r				
VBMT 160404	MM	0,12 - 0,25	0,4 - 3,00	9,52	4,76	0,4		5073346	5101440	
VBMT 160408	MM	0,15 - 0,30	0,8 - 3,00	9,52	4,76	0,8		5073345	5101442	
VCGT 050102	FM	0,07 - 0,13	0,2 - 1,00	3,1	1,59	0,2			5120563	5124312
VCMT 160404	BSMS	0,20 - 0,50	0,40 - 4,00	9,52	4,76	0,4		6407783		
VCMT 160408	BSMS	0,20 - 0,50	0,80 - 4,00	9,52	4,76	0,8		6407790		
VCMT 160412	BSMS	0,20 - 0,50	1,20 - 4,00	9,52	4,76	1,2		6407798		
VCMT 070202	FM	0,05 - 0,13	0,20 - 1,50	3,97	2,38	0,2			5106924	5106923
VCMT 070204	FM	0,08 - 0,20	0,40 - 1,50	3,97	2,38	0,4			5106926	5106925
VCMT 110302	FM	0,05 - 0,13	0,20 - 1,50	6,35	3,18	0,2			5106939	5106931
VCMT 110304	FM	0,08 - 0,20	0,40 - 1,50	6,35	3,18	0,4			5106947	5106945
VCMT 160404	MM	0,15 - 0,40	0,40 - 3,00	9,52	4,76	0,4	5113372		5092767	
VCMT 160408	MM	0,15 - 0,40	0,80 - 3,00	9,52	4,76	0,8	5113374		5092770	
VCMT 160412	MM	0,15 - 0,40	1,20 - 3,00	9,52	4,76	1,2			5092771	

Bestellbeispiel Order example: 10 Stück 10 pieces VBMT 160404-MM LC435D oder or 5073346

Verfügbar ab Lager Available from stock

	Sorte Grade			ISO-Klasse ISO-class		
	LCM20T LC435D BCM25T BCM40T			HC-M20 HC-M35 HC-M25 HC-M40		
WNMG....-BFMS medium fine 	WNMG....-BMRS medium rough 	WNMG....-BMS medium 	WNMG....E.-BC copy 	WNMG....-MM medium 	WNMG....-MRM medium rough 	

Type Type	Geometrie Geometry	Vorschub Feed f [mm / U rev]	Schnitttiefe cutting depth ap max. [mm]	Abmessungen [mm] Dimensions [mm]			LCM20T	LC435D	BCM25T	BCM40T
				d	s	r				
WNMG 060404	BFMS	0,10 - 0,30	0,40 - 4,00	9,52	4,76	0,4		6400388		
WNMG 080404	BFMS	0,10 - 0,30	0,40 - 5,50	12,7	4,76	0,4		6400389	5092773	
WNMG 080408	BFMS	0,10 - 0,30	0,80 - 5,50	12,7	4,76	0,8		6400390	5092774	
WNMG 080408	BMRS	0,32 - 0,60	0,80 - 5,50	12,7	4,76	0,8		6400428	5101443	5101444
WNMG 080412	BMRS	0,32 - 0,60	1,20 - 5,50	12,7	4,76	1,2		6400429	5101445	5101446
WNMG 060408	BMS	0,16 - 0,40	0,80 - 4,00	9,52	4,76	0,8		6400391		
WNMG 080408	BMS	0,16 - 0,40	0,80 - 5,50	12,7	4,76	0,8		6400392		
WNMG 080412	BMS	0,20 - 0,45	1,20 - 5,50	12,7	4,76	1,2		6400393		
WNMG 080416	BMS	0,25 - 0,45	1,60 - 5,50	12,7	4,76	1,6		6400427		
WNMG 080404	ER-BC	0,10 - 0,25	0,40 - 5,50	12,7	4,76	0,4		6410972		
WNMG 080408	EL-BC	0,20 - 0,45	0,80 - 5,50	12,7	4,76	0,8		6410976		
WNMG 080408	ER-BC	0,20 - 0,45	0,80 - 5,50	12,7	4,76	0,8		6410980		
WNMG 080412	EL-BC	0,20 - 0,45	1,20 - 5,50	12,7	4,76	1,2		6411651		
WNMG 080412	ER-BC	0,20 - 0,45	1,20 - 5,50	12,7	4,76	1,2		6411654		
WNMG 060404	MM	0,15 - 0,50	0,40 - 4,00	9,52	4,76	0,4			5092772	
WNMG 080408	MM	0,15 - 0,40	0,80 - 5,50	12,7	4,76	0,8	5060171		5092775	
WNMG 080412	MM	0,15 - 0,40	1,20 - 5,50	12,7	4,76	1,2	5060526		5092788	
WNMG 080416	MM	0,15 - 0,40	1,60 - 5,50	12,7	4,76	1,6			5092789	
WNMG 080408	MRM	0,20 - 0,50	0,80 - 5,00	12,7	4,76	0,8	5151912		5151913	5151915
WNMG 080412	MRM	0,20 - 0,50	1,20 - 5,00	12,7	4,76	1,2	5151916		5151917	5151919

Werkstoffgruppe Material group			Brinell Härte HB Brinell hardness HB	LCM20T			
				Negative Wendepplatten Negative indexable inserts ISO-P-System		Positive Wendepplatten Positive indexable inserts ISO-S-System	
				Geometrie Geometry	Schnittgeschwindigkeit v_c (m/min) Cutting speed v_c (m/min)	Geometrie Geometry	Schnittgeschwindigkeit v_c (m/min) Cutting speed v_c (m/min)
M	Ferritisch Ferritic 1.4000, 1.4002, 1.4003, 1.4006, 1.4016, 1.4104, 1.4113, 1.4313, 1.4742, 1.4762	180	MM	180 – 230	MM	180 – 230	
			MRM	150 – 230	FM	180 – 230	
	Martensitisch Martensitic 1.4006, 1.4014, 1.4021, 1.4024, 1.4027, 1.4028, 1.4031, 1.4034, 1.4057, 1.4122, 1.4724	320	MM	180 – 230	MM	180 – 230	
			MRM	150 – 230	FM	180 - 230	
Austenitisch Austenitic 1.4300, 1.4301, 1.4303, 1.4305, 1.4306, 1.4308, 1.4310, 1.4311	180	MM	150 - 200	MM	150 – 200		
		MRM	130 - 200	FM	130 - 200		
	1.4321, 1.4401, 1.4404, 1.4406, 1.4428, 1.4435, 1.4436, 1.4438, 1.4449 1.4571	180	MM	150 – 200	MM	150 – 200	
			MRM	130 - 200	FM	130 - 200	

Die angegebenen Schnittdatenrichtwerte sind Empfehlungen für Anwendungen mit Kühlschmierstoff.
Bei Trockenbearbeitung reduzieren Sie die Schnittgeschwindigkeit v_c um ca. 20 %.
The above recommendations are given for wet machining. For dry machining the recommended values for the cutting speed have to be reduced by approx. 20 %.

Werkstoffgruppe Material group			Brinell Härte HB Brinell hardness HB	BCM25T			
				Negative Wendepplatten Negative indexable inserts ISO-P-System		Positive Wendepplatten Positive indexable inserts ISO-S-System	
				Geometrie Geometry	Schnittgeschwindigkeit v_c (m/min) Cutting speed v_c (m/min)	Geometrie Geometry	Schnittgeschwindigkeit v_c (m/min) Cutting speed v_c (m/min)
M	Ferritisch Ferritic 1.4000, 1.4002, 1.4003, 1.4006, 1.4016, 1.4104, 1.4113, 1.4313, 1.4742, 1.4762	180	MM	130 - 200	MM	130 - 200	
			BFMS	130 - 200	FM	130 - 200	
			BMS	130 - 200			
	Martensitisch Martensitic 1.4006, 1.4014, 1.4021, 1.4024, 1.4027, 1.4028, 1.4031, 1.4034, 1.4057, 1.4122, 1.4724	320	MM	130 - 200	MM	130 - 200	
			BFMS	130 - 200	FM	130 - 200	
			BMS	130 - 200			
Austenitisch Austenitic 1.4300, 1.4301, 1.4303, 1.4305, 1.4306, 1.4308, 1.4310, 1.4311 1.4321, 1.4401, 1.4404, 1.4406, 1.4428, 1.4435, 1.4436, 1.4438, 1.4449 1.4571	180	MM	100 - 180	MM	100 - 180		
		BFMS	100 - 180	FM	100 - 180		
		BMS	100 - 180				
	180	MM	100 - 180	MM	100 - 180		
		BFMS	100 - 180	FM	100-180		
		BMS	100 - 180				
	MRM	90 - 180					

Die angegebenen Schnittdatenrichtwerte sind Empfehlungen für Anwendungen mit Kühlschmierstoff.

Bei Trockenbearbeitung reduzieren Sie die Schnittgeschwindigkeit v_c um ca. 20 %.

The above recommendations are given for wet machining. For dry machining the recommended values for the cutting speed have to be reduced by approx. 20 %.

Werkstoffgruppe Material group			Brinell Härte HB Brinell hardness HB	BCM40T / LC435D			
				Negative Wendepplatten Negative indexable inserts ISO-P-System		Positive Wendepplatten Positive indexable inserts ISO-S-System	
				Geometrie Geometry	Schnittgeschwindigkeit v_c (m/min) Cutting speed v_c (m/min)	Geometrie Geometry	Schnittgeschwindigkeit v_c (m/min) Cutting speed v_c (m/min)
M	Ferritisch Ferritic 1.4000, 1.4002, 1.4003, 1.4006, 1.4016, 1.4104, 1.4113, 1.4313, 1.4742, 1.4762	180	MM	100 - 180	MM	100 - 180	
					FM	100 - 180	
			BMRS	100 - 180			
			MRM	100-180			
	Martensitisch Martensitic 1.4006, 1.4014, 1.4021, 1.4024, 1.4027, 1.4028, 1.4031, 1.4034, 1.4057, 1.4122, 1.4724	320	MM	100 - 180	MM	100 - 180	
					FM	100 - 180	
			BMRS	100 - 180			
			MRM	100 - 180			
	Austenitisch Austenitic 1.4300, 1.4301, 1.4303, 1.4305, 1.4306, 1.4308, 1.4310, 1.4311	180	MM	90 - 160	MM	90 - 160	
					FM	90 - 160	
			BMRS	80 - 160			
			MRM	80 - 160			
1.4321, 1.4401, 1.4404, 1.4406, 1.4428, 1.4435, 1.4436, 1.4438, 1.4449 1.4571	180	MM	90 - 160	MM	90 - 160		
				FM	90 - 160		
		BMRS	80 - 160				
		MRM	80 - 160				

Die angegebenen Schnittdatenrichtwerte sind Empfehlungen für Anwendungen mit Kühlschmierstoff.
 Bei Trockenbearbeitung reduzieren Sie die Schnittgeschwindigkeit v_c um ca. 20 %.
 The above recommendations are given for wet machining. For dry machining the recommended values for the cutting speed have to be reduced by approx. 20 %.

Vergleich Comparison					
ISO	ANSI	ISO	ANSI	ISO	ANSI
CCGT 030101	CCGT (1.2) 1 (.2)	DCGT 04T002	-	SCMT 120408	SCMT 432
CCGT 030102	CCGT (1.2) 1 (.5)	DCGT 070204	DCGT 2 (1.5) 1		
CCGT 060204	CCGT 2 (1.5) 1	DCGT 11T304	DCGT 3 (2.5) 1	SNMG 090304	SNMG 321
CCGT 060208	CCGT 2 (1.5) 2	DCGT 11T308	DCGT 3 (2.5) 2		
CCGT 09T304	CCGT 3 (2.5) 1			SNMG 120408	SNMG 432
CCGT 09T308	CCGT 3 (2.5) 2	DCMT 070202	DCMT 2 (1.5) (.5)	SNMG 120412	SNMG 433
CCGT 120408	CCGT 432	DCMT 070204	DCMT 2 (1.5) 1	SNMG 150612	SNMG 543
CCGT 120412	CCGT 433	DCMT 11T302	DCMT 3 (2.5) (.5)	SNMG 150616	SNMG 544
		DCMT 11T304	DCMT 3 (2.5) 1	SNMG 190612	SNMG 643
CCMT 060202	CCMT 2 (1.5) (.5)	DCMT 11T308	DCMT 3 (2.5) 2	SNMG 190616	SNMG 644
CCMT 060204	CCMT 2 (1.5) 1				
CCMT 09T304	CCMT 3 (2.5) 1	DNMG 110404	DNMG 331		
CCMT 09T308	CCMT 3 (2.5) 2	DNMG 110408	DNMG 332		
CCMT 120404	CCMT 431	DNMG 150404	DNMG 431		
CCMT 120408	CCMT 432	DNMG 150408	DNMG 432		
		DNMG 150604	DNMG 441		
CNMG 090304	CNMG 321	DNMG 150608	DNMG 442		
CNMG 120404	CNMG 431	DNMG 150612	DNMG 443		
CNMG 120408	CNMG 432				
CNMG 120412	CNMG 433				
CNMG 160608	CNMG 542				
CNMG 160612	CNMG 543				
CNMG 160616	CNMG 544				
CNMG 190612	CNMG 643				
CNMG 190616	CNMG 644				

Vergleich Comparison					
ISO	ANSI	ISO	ANSI	ISO	ANSI
TCGT 110204	TCGT 2 (1.5) 1	VBMT 160404	VBMT 331	WNMG 060404	WNMG 331
		VBMT 160408	VBMT 332	WNMG 060408	WNMG 332
TCGT 16T304	TCGT 3 (2.5) 1			WNMG 080404	WNMG 431
TCGT 16T308	TCGT 3 (2.5) 2	VCGT 050102	-	WNMG 080408	WNMG 432
				WNMG 080412	WNMG 433
TCMT 110204	TCMT 2 (1.5) 1	VCMT 070202	-	WNMG 080416	WNMG 434
TCMT 110208	TCMT 2 (1.5) 2	VCMT 070204	-		
TCMT 16T304	TCMT 3 (2.5) 1	VCMT 160404	VCMT 331		
TCMT 16T308	TCMT 3 (2.5) 2	VCMT 160408	VCMT 332		
		VCMT 160412	VCMT 333		
TNMG 160404	TNMG 331				
TNMG 160408	TNMG 332				
TNMG 160412	TNMG 333				
TNMG 220408	TNMG 432				
TNMG 220412	TNMG 433				

Boehlerit GmbH & Co. KG
Werk VI-Strasse 100
8605 Kapfenberg
Österreich/Austria
Telefon +43 3862 300 - 0
Telefax +43 3862 300 - 793
info@boehlerit.com
www.boehlerit.com

boehlerit

Vertriebstöchter und Repräsentanten *Subsidiaries and representatives*

Brasilien/Brazil

Boehlerit Brasil Ferramentas Ltda.
Rua Capricórnio 72
Alpha Conde Comercial I
06473-005 - Barueri -
São Paulo
Tel. +55 11 554 60 755
Fax +55 11 554 60 476
info@boehlerit.com.br
www.boehlerit.com.br

Deutschland/Germany

(Verschleiß/Wear parts)
Boehlerit GmbH & Co. KG
Heidenheimer Straße 108
D-73447 Oberkochen
Telefon +49 7364 950-700
Telefax +49 7364 950-720
bid@boehlerit.de
www.boehlerit.de

Indien/India

Boehlerit India
Otto Bilz Private Limited
No.5A-5B/6A,
KIADB Industrial Area
Doddaballapur-561 203
Bangalore District, Karnataka
Tel. +91-080-22638700
Fax +91-080-22638702
Venkat@bilztool.com
www.boehlerit.com

Italien/Italy

Boehlerit Italy S.r.l.
Via Papa Giovanni XXIII, Nr. 45
20090 Rodano (MI)
Tel. +39 02 269 49 71
Fax +39 02 218 72 456
info@boehlerit.it
www.boehlerit.it

Mexiko/Mexico

Boehlerit S.A. de C.V.
Av. Acueducto No. 15
Parque Industrial Bernardo Quintana
El Marqués, Querétaro
México. C.P. 76246
Tel. +52 442 221 5706
Fax +52 442 221 5555
info@boehlerit.com.mx
www.boehlerit.com.mx

Österreich/Austria

Boehlerit GmbH & Co. KG
Werk VI-Straße 100
8605 Kapfenberg
Österreich/Austria
Telefon +43 3862 300 - 0
Telefax +43 3862 300 - 793
sales-at@boehlerit.com
www.boehlerit.com

Polen/Poland

Boehlerit Polska sp.z.o.o.
Zlotniki, ul. Kobaltowa 6
62-002 Suchy Las
Tel. +48 61 659 38 00
Fax +48 61 623 20 14
info@boehlerit.pl
www.boehlerit.pl

Slowakei/Slovakia

Kancelár Boehlerit
Santraziny 753
760 01 Zlín
Tel. +420 577 214 989
Fax +420 577 219 061
boehlerit@boehlerit.sk
www.boehlerit.sk

Spanien/Spain

Boehlerit Spain S.L.
C/. Narcis Monturiol 11-15
08339 Vilassar de Dalt Barcelona
Tel. +34 93 750 7907
Fax +34 93 750 7925
info@boehlerit.es
www.boehlerit.es

Tschechien/Czech Republic

Kancelár Boehlerit
Santraziny 753
760 01 Zlín
Tel. +420 577 214 989
Fax +420 577 219 061
boehlerit@boehlerit.cz
www.boehlerit.cz

Türkei/Turkey

Boehlerit
Sert Metal ve Takım San. ve Tic. A.Ş.
Gosb 1600. Sok.No: 1602
41480 Gebze - Kocaeli
Tel. +90 262 677 1737
Fax +90 262 677 1746
info@boehlerit.com.tr
www.boehlerit.com.tr

Ungarn/Hungary

Boehlerit Hungária Kft.
2036 Érdliget Pf. 32
2030-Érd, Kis-Duna u.6.
Tel. +36 23 521 915
Fax +36 23 521 919
info@boehlerit.hu
www.boehlerit.hu

USA

Kanada/Canada

Boehlerit USA
Bilz USA
1140 No.Main St.
Lombard IL 60148
Tel. +1 847 734 9390
Fax +1 847 734 9391
www.boehlerit.com